

BERNARDO®

www.bernardo.at



01 | 2024

DRILLING, MULTI-BORING AND CHISEL MORTISING MACHINES

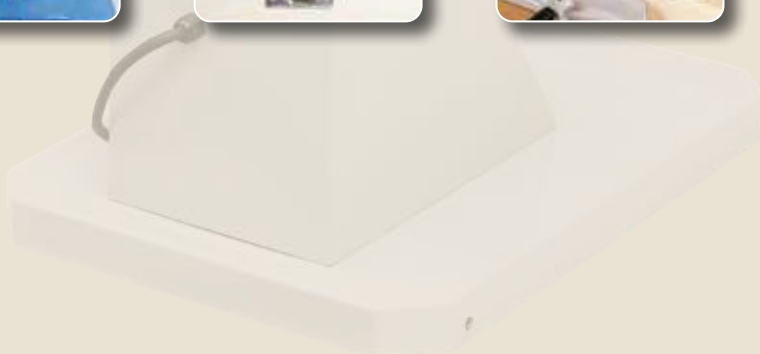
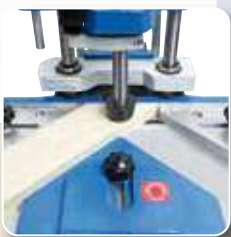

KNF 1
KNF 2
KNF 2 P
BBM 35 M
BBM 35 P
HM 12 P
HM 25
HM 25 TOP
HM 30 Porta
LBM 150 P

LBM 220
LBM 350 T
Multibor DB 21

Drill heads

Drill heads in various designs are available for borehole rows, as well as window fittings and hinges. Heads are suitable for drill presses, handheld models as well as mortising machines.

Multi-spindle head attachment - spaced 32 mm



Equipped with five spindles, this head attachment is suitable for simultaneous drilling of a series of five holes spaced 32 mm from each other. This accessory is also suitable for drilling side parts of furniture and mounting of hinge bases.



Picture shows optional accessories

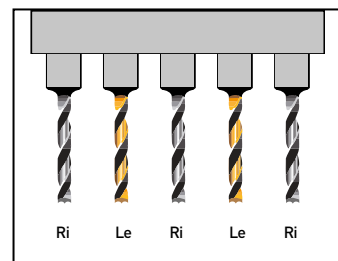

Art. no.	Description	excl. VAT
14-1105	Multi-spindle head attachment 32 mm, suitable for drilling machines	
14-1106	Multi-spindle head attachment 32 mm, suitable for mortising machines	

Optional accessories:

Dowel drill bit

on request

Drill template for hinges



The drill head for hinges type Blum or Grass features three spindles and is suitable for simultaneous drilling of the three holes which are needed for mounting the hinges.

Types of hinges

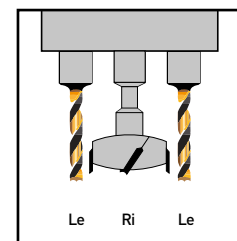
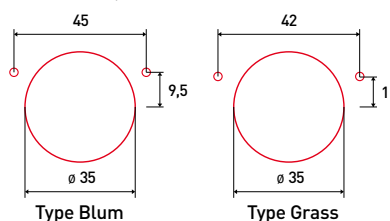

14-1109	Drill head 42/11 for hinge typ Grass, with collet for drilling machines
14-1110	Drill head 42/11 for hinge typ Grass, with collet for mortising machines*
14-1111	Drill head 45/9,5 for hinge typ Blum, with collet for drilling machines
14-1112	Drill head 45/9,5 for hinge typ Blum, with collet for mortising machines*

Optional accessories:

Hinge and dowel drill bit

on request

Drill head for window fittings

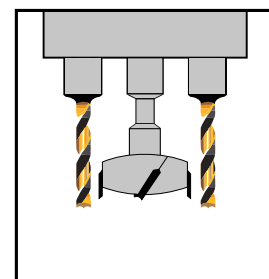
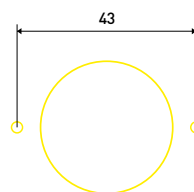

This drill head is suitable for window handles that feature mounting screws spaced 43 mm.

Example for Drill sets for grip holes

14-1103	Drill head 43 mm for window handles with collet for drilling machines
14-1104	Drill head 43 mm for window handles with collet for mortising machines*

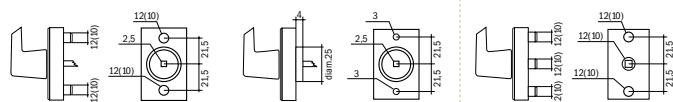

* with collet 25 mm

Drills are not included in standard accessories.

Keyway milling machine

KNF 1

Drilling, multi-boring
and chisel mortising

The KNF 1 manual keyway milling machine is a compact bench model for making one keyway per stroke. Various frames, such as picture frames, wreath frames, segmental arches, window frames and many more, are quickly produced at low cost.

- Shape and force ensure strong connection without the need of adhesives
- Depending on type of application and material, dovetail milling cutters are available in various lengths
- Fully equipped with adjustable fences to allow for convenient workpiece positioning
- Quick and cost efficient assembly of connections, highly economical for production of small to medium sized series
- Low weight makes this model ideal for transport between sites and for assembly works



Examples of use



The 850 W motor is suitable for production of dovetails W-1, W-2 and W-3.



Operating mode: Lowering the lever clamps the workpiece into place. Milling cutter lowers to set depth. Lifting the lever into starting position releases the workpiece and motor stops automatically.



BERNARDO
SEMIPROFESSIONAL

Standard accessories:

- 1 pc. milling cutter for key size W-2
- Mitre fence 45°
- 2 sidewise fence
- Manual downholder

Technical data	KNF 1
Mill holder Ø	6 mm
Milling depth	0 - 55 mm
Table size	380 x 220 mm
Control	manual
Workpiece clamping	manual
Fence length	390 mm
Width of profile max.	185 mm
Clearance max.	95 mm
Speed	32000 rpm
Motor power	0,85 kW
Voltage	230 V
Machine dimension (W x D x H)	400 x 620 x 535 mm
Weight approx.	10 kg
Art. no.	14-2115

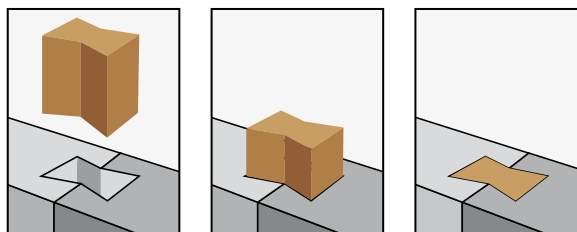

Optional accessories:

- Dovetail milling cutter W-1*
- Dovetail milling cutter W-2*
- Dovetail milling cutter W-3*
- Hoffmann-key

Art. no.	excl. VAT
16-2030	
16-2031	
16-2032	
	on request

Twin keyway milling machine

Pneumatic twin keyway milling machine

- Equipped with adjustable fences to allow for convenient positioning of workpiece
- Cost efficient production of frame connections of various kinds, eg. drawers, picture frames, door cladding, wreath frames, segmental arches, window frames and many more
- Quick and low cost connections are particularly economical for production of small to medium sized series
- Shape and force ensure strong connections – no adhesives required
- Depending on type of application and material, there are different key sizes and lengths available
- Operating mode: lowering lever secures workpiece into places, milling cutters lower to the set depth. Lifting the lever releases workpiece – motor switches off automatically



Example of use

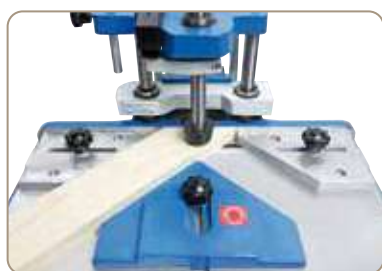

Adjustable fences for optimal positioning and clamping of workpiece come standard.



Simultaneous production of two keyways with fixed spacing of 28 mm.

**Best
Price**

BERNARDO[®]
www.bernardo.at
SEMI PROFESSIONAL



Technical data	KNF 2	KNF 2 P
Mill holder Ø	6 mm	6 mm
Milling depth	0 - 55 mm	0 - 50 mm
Table size	380 x 220 mm	390 x 220 mm
Control	manual	pneumatic
Workpiece clamping	manual	pneumatic
Spindle distance	28 mm	28 mm
Needed air pressure	-	6 - 8 bar
Fence length	390 mm	390 mm
Width of profile max.	185 mm	185 mm
Clearance max.	85 mm	100 mm
Speed	32000 rpm	32000 rpm
Motor power	0,85 kW	0,85 kW
Voltage	230 V	230 V
Machine dimension (W x D x H)	400 x 500 x 730 mm	400 x 620 x 480 mm
Weight approx.	16 kg	14 kg
Art. no.	14-2116	14-2117

Standard accessories:

- 2 pcs. milling cutter for key size W-2
- Mitre fence 45°
- 2 sidewise fence
- Manual downholder (KNF 2)
- Pneumatic downholder (KNF 2 P)
- Foot pedal (KNF 2 P)

The KNF 2 and KNF 2 P twin keyway milling machines are suitable for connecting wider frame parts, such as hand railings, segmental arches, arched windows, corner benches etc. Two keyway segments are produced in one go. The KNF 2 P model additionally features a pneumatic downholder controlled by a foot pedal.

KNF 2 KNF 2 P

Drilling, multi-boring
and chisel mortising

BERNARDO
www.bernardo.at
SEMI PROFESSIONAL



Individual adjustment of milling depth to desired dovetail length.



The dovetail shape interlocks frame parts strongly in shape and force.



Maximum clearance of 100 mm, maximum milling depth 50 mm (KNF 2 P).



Powerful drive motor for milling of keyway with key sizes W-1, W-2 and W-3.

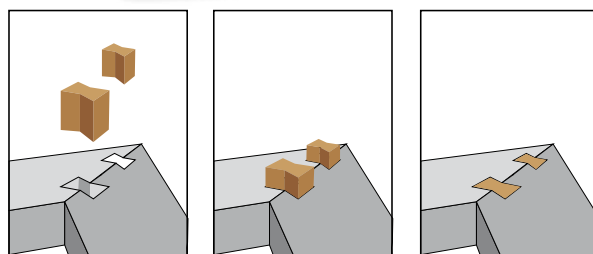
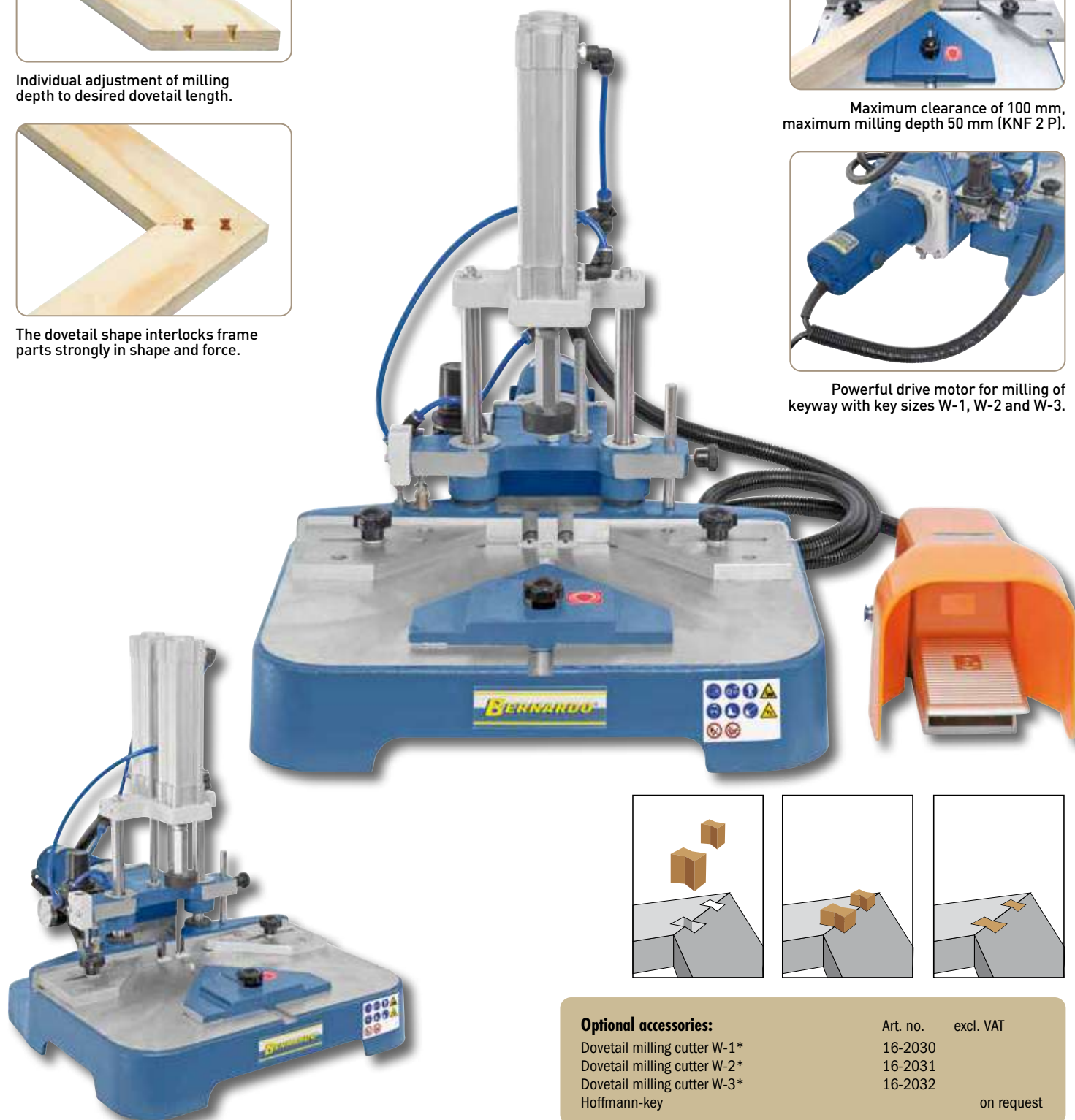

Optional accessories:

- Dovetail milling cutter W-1*
- Dovetail milling cutter W-2*
- Dovetail milling cutter W-3*
- Hoffmann-key

Art. no.	excl. VAT
16-2030	
16-2031	
16-2032	
	on request

Manual hinge drilling machine

Pneumatic hinge drilling machine

- Comes complete with adjustable end stop depth of hole
- Compact construction, suitable for transport between sites (BBM 35 M)
- Model BBM 35 M is extremely user-friendly, no pressure required
- Powerful motor (0.75 kW) designed for continuous operation
- Excellent for drilling of hinges on furniture – Blum or Grass
- Model BBM 35 P features an extensive range of accessories



3-spindle drill unit with hinge drill of 35 mm left and 2x drill bits, each 2 mm in diameter right.

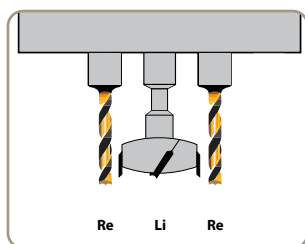

The middle hinge drill is left turning, the ones on the side are right turning.

User-friendly



Efficient and cost-efficient fixing of hinges.

BERNARDO
SEMIPROFESSIONAL

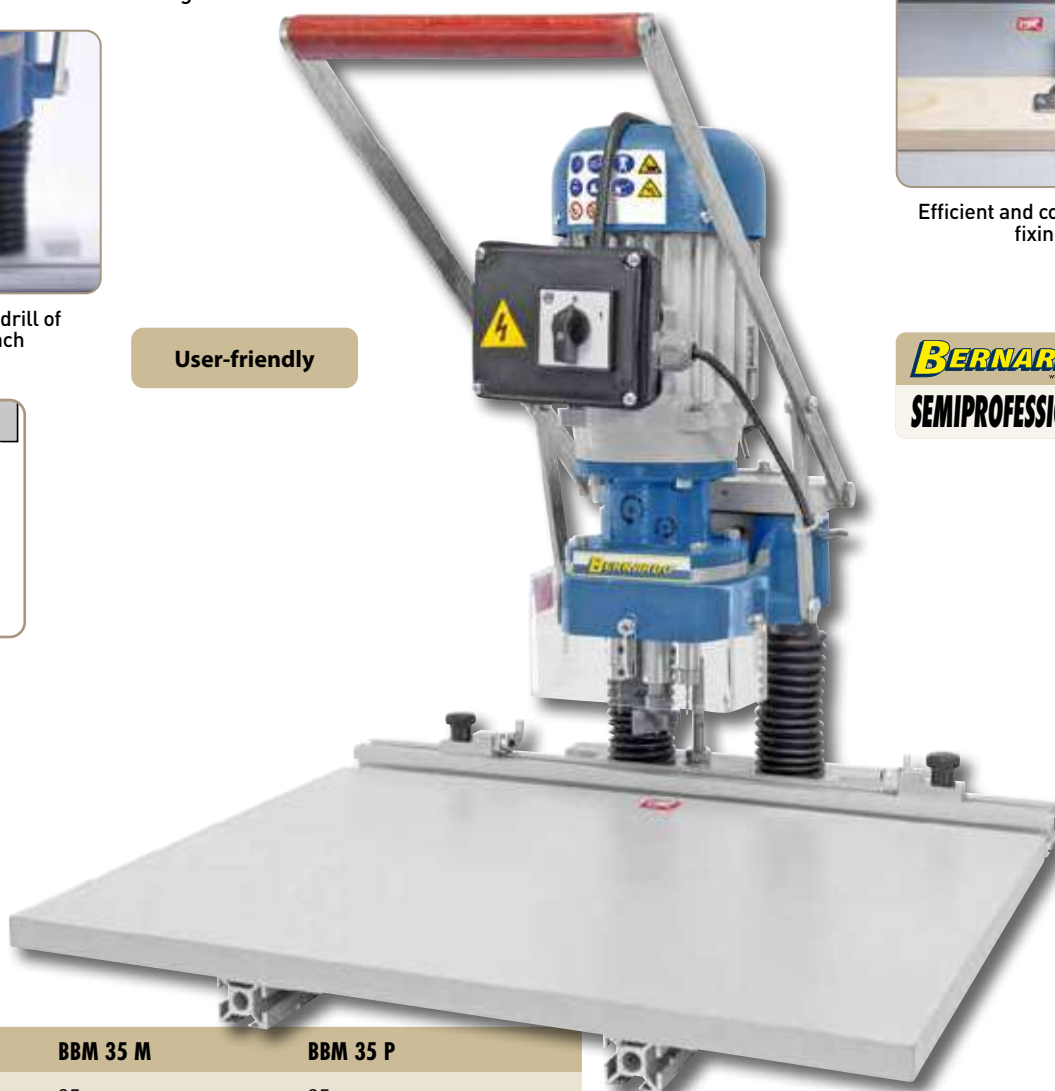

Technical data	BBM 35 M	BBM 35 P
Drill diameter	35 mm	35 mm
Quantity of spindles	3 pcs.	3 pcs.
Control	manual	pneumatic
Workpiece clamping	manual	pneumatic
Distance table/spindle max.	85 mm	85 mm
Distance table/drill max.	50 mm	50 mm
Table size	500 x 350 mm	500 x 350 mm
Table movable	105 mm	105 mm
Fence length (incl. extension)	500 mm	1500 mm
Necessary air pressure	-	6 - 8 bar
Speed	3000 rpm	3000 rpm
Motor power	0,75 kW	0,75 kW
Voltage	230 V	230 V
Machine dimension (W x D x H)	500 x 500 x 520 mm	500 x 520 x 500 mm*
Weight approx.	19 kg	25 kg
Art. no.	10-1013 BBM 35 M - Blum 10-1015 BBM 35 M - Grass	10-1014 BBM 35 P - Blum 10-1016 BBM 35 P - Grass

Standard accessories BBM 35 M:

- Hinge drill diam. 35 mm left
- 2 pcs. drill diam. 2 mm right
- 3-spindle drilling unit
- 0,5 m fence with 2 stops
- Manual hand lever
- Working table

Standard accessories BBM 35 P:

- Hinge drill diam. 35 mm left
- 2 pcs. drill diam. 2 mm right
- 3-spindle drilling unit
- Drilling unit with pneumatic feed
- 1,5 m fence with 2 stops
- 2 pcs. pneumatic downholder
- Air pistol
- Foot pedal
- Working table

* without sidewise fence

The BBM 35 hinge drill is available as a manual model or with pneumatic drill feed. Both models are suitable for the hinge systems of Blum or Grass, making these drills ideal devices for small businesses and craftsmen.

BBM 35 M BBM 35 P

Drilling, multi-boring
and chisel mortising



Pneumatic downholder (BBM 35 P) allows for ideal clamping of workpiece.

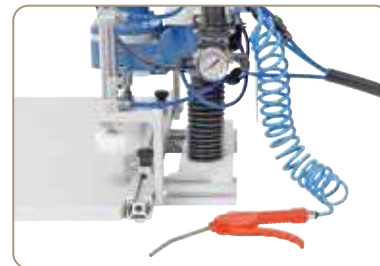

Complete with air pistol.



Maintenance-free aluminium feed cylinder.

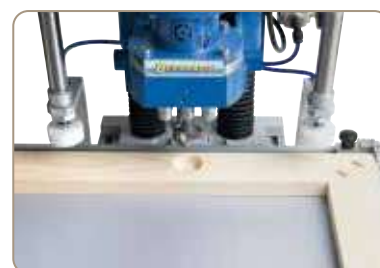

Comes complete with tiltable fences, ideal for repetitive operations.

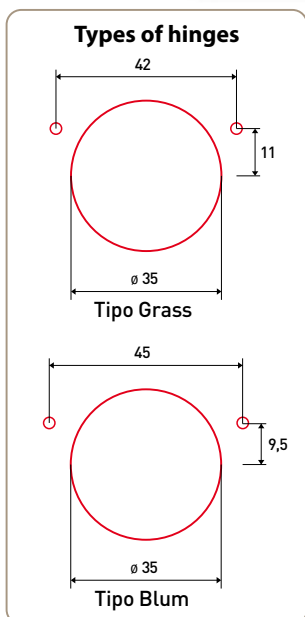
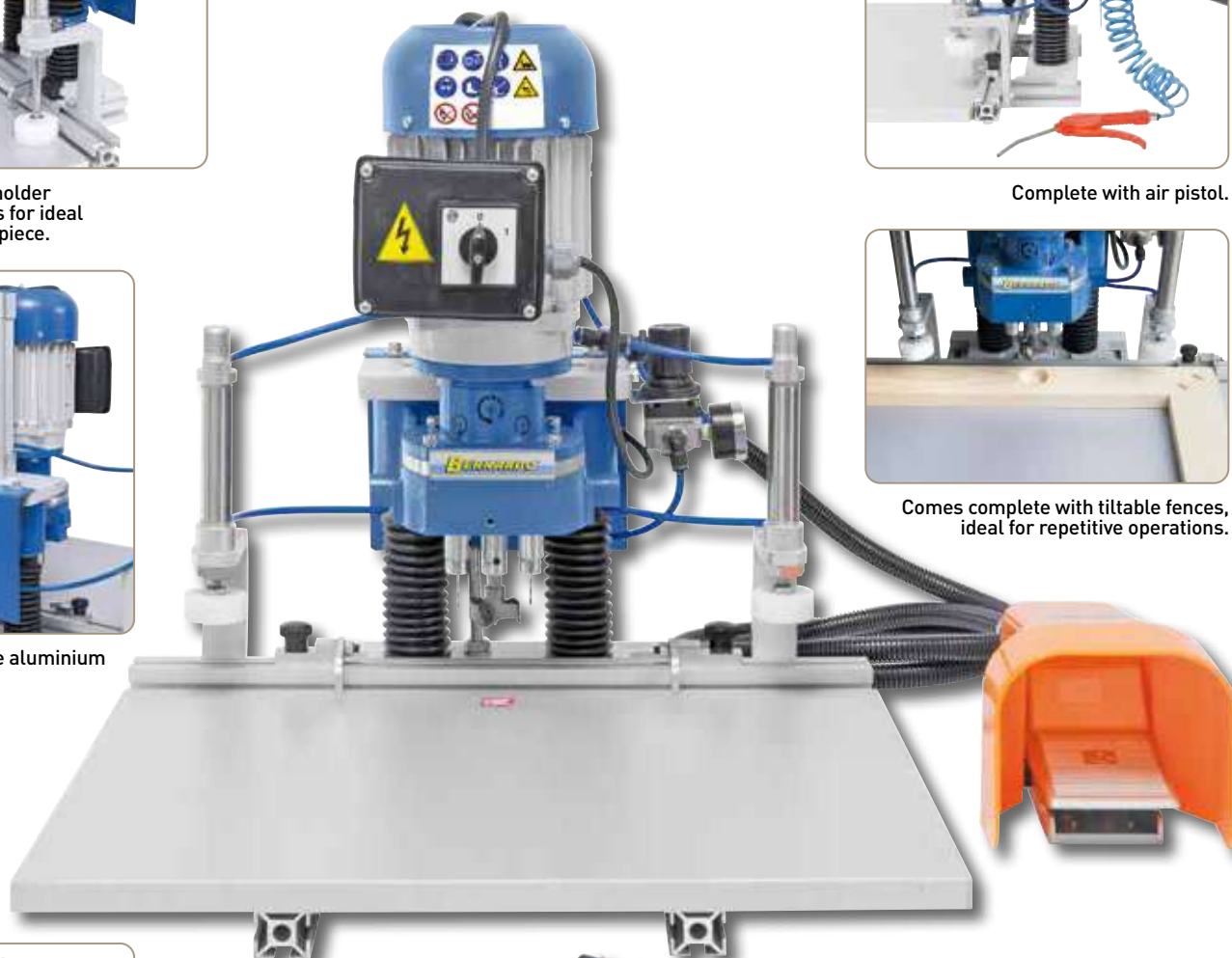

Optional accessories:

- Hinge drill HW, D35, NL31, GL57, S10, RE
- Drill 2 mm, clockwise

Art. no.	excl. VAT
16-2072	
16-2073	

Chisel mortising machine

HM 12 P

The HM 12 P mortising machine is a compact bench model which is incredibly easy to operate, making it ideal for amateurs.

- Gear rack allows for easy height adjustment of drill head
- Suitable for mortising of rectangular holes for tenon joints etc.
- Solid double column guide ensures precise results
- Adjustable drill depth stop guarantees consistent accuracy
- Ideal for slotting and mortising of hard and soft timbers



Features convenient chisel holder for tool storage.



Powerful aluminium motor in accordance with IP 54 standards.



Adjustable workpiece fence allows for high repeat accuracy when mortising.

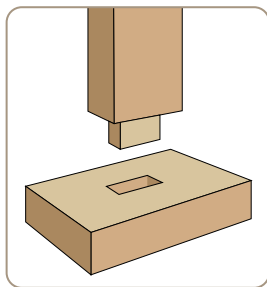

Example of use: tenon joints



BERNARDO
www.bernardo.at
HOBBY

Technical data

HM 12 P

Chisel size max.	12,7 mm
Drill stroke	130 mm
Max. workpiece height	130 mm
Table size	340 x 140 mm
Speed	1400 rpm
Motor power	0,37 kW (0,5 HP)
Voltage	230 V
Machine dimension (W x D x H)	340 x 390 x 700 mm
Weight approx.	26 kg
Art. no.	14-2085B

Standard accessories:

- Drill chuck 13 mm
- Adjustable fence
- Chisel holder

Optional accessories:

- Mortising chisel 6,35 mm, 19 mm shaft
- Mortising chisel 8,00 mm, 19 mm shaft
- Mortising chisel 9,50 mm, 19 mm shaft
- Mortising chisel 12,70 mm, 19 mm shaft

Art. no.	excl. VAT
14-1000	
14-1001	
14-1002	
14-1003	

Chisel mortising machine

HM 25

Drilling, multi-boring
and chisel mortising

The HM 25 mortising machine features an extensive range of accessories (quick clamping device, longitudinal fence etc.) allowing for convenient, fast and efficient processing of a series of rectangular holes. Another advantage of this model particularly for large workpieces is the up to 180° swivelling spindle head.

- Complete with handwheels for changing the coordinate table
- Drill chuck accessible from both sides for convenient change of mortising chisels
- Adjustable dovetail guiding in all axis
- Spindle head swivels 180°, essential for mortising works on doors
- Includes gas pressure cylinder to support mortising
- Ideal for slotting and mortising of soft and hard timbers
- Grey cast-iron machine frame eliminates vibrations and promotes accuracy

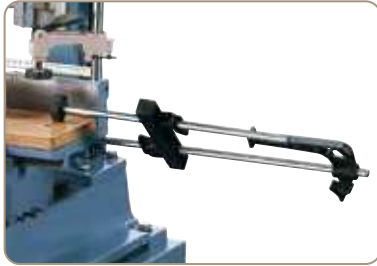

Convenient longitudinal fence for repeated operations.



Spindle head adjusts 180° to allow mortising of door locks and hinges.



Eccentric clamp and quick clamping vice for secure fastening of workpiece.

Following drill heads are available:

- Gang drill head 32 mm
- Drill head for hinges type Grass
- Drill head for hinges type Blum
- Drill head for window fittings



BERNARDO
SEMIPROFESSIONAL

Standard accessories:

- Drill chuck 16 mm
- 2 pcs. eccentric holder
- Longitudinal fence
- Drill depth stop with scale
- Quick clamping vice
- Gas pressure balancing cylinder
- Movable coordinate table

Picture shows drill head for window fittings and machine stand. (optional accessories)

Technical data	HM 25
Chisel size max.	25,4 mm
Drill stroke	230 mm
Max. mortising depth	76 mm
Max. workpiece height	200 mm
Max. workpiece width	145 mm
Table size	400 x 150 mm
Travel (x / y)	175 / 150 mm
Speed	2850 rpm
Motor power	0,75 kW (1,0 HP)
Voltage	230 V
Machine dimension (W x D x H)*	430 x 610 x 1100 mm
Weight approx.	100 kg
Art. no.	14-2090

* without stand

Optional accessories:

Mortising chisel 6,35 mm, 19 mm shaft	Art. no.	14-1000	excl. VAT
Mortising chisel 8,00 mm, 19 mm shaft		14-1001	
Mortising chisel 9,50 mm, 19 mm shaft		14-1002	
Mortising chisel 12,70 mm, 19 mm shaft		14-1003	
Mortising chisel 15,87 mm, 19 mm shaft		14-1004	
Mortising chisel 19,00 mm, 19 mm shaft		14-1005	
Mortising chisel 25,40 mm, 19 mm shaft		14-1006	
Gang drill head 32 mm		14-1106	
Drill head 43 mm for window handle		14-1104	
Drill head 42/11 for hinge type Grass		14-1110	
Drill head 45/9,5 for hinge type Blum		14-1112	
Stand with tool shelf		14-2095	

Chisel mortising machine

HM 25 TOP

The HM 25 Top is an enhancement of the HM 25 mortising machine. The spindle head can be tilted to the right and to the left up to 22.5°. The work table tilts to the front and the back.

- For mortising of rectangular shaped holes for tenon joints etc.
- Adjustable drill depth stop ensures repeat accuracy when mortising
- Eccentric clamp can be adjusted quickly to secure workpiece to table
- Includes gas pressure cylinder to support mortising
- Ideal for slotting and mortising of hard and soft timbers



Work table tilts to front and back, which increases the range of applications significantly.



Spindle head tilts to the right and to the left up to 22.5°.



Choice of drill heads are optionally available.



Technical data	HM 25 TOP	HM 30 Porta
Chisel size max.	25,4 mm	25,4 mm
Drill stroke	230 mm	180 mm
Max. mortising depth	76 mm	76 mm
Max. workpiece height	200 mm	1150 mm
Max. workpiece width	185 mm	210 mm
Table size	540 x 190 mm	500 x 150 mm
Table tiltable left / right	-	45° / 45°
Tilting range work table forward / backward	22,5° / 22,5°	-
Tilting range spindle head	22,5° / 22,5°	-
Drill head sidewise movable	-	235 mm
Drill head forward / backward movable	-	100 mm
Travel (x / y)	280 / 135 mm	-
Speed	1400 rpm	1400 rpm
Motor power	0,75 kW (1,0 HP)	1,1 kW (1,5 HP)
Voltage	230 V	400 V
Machine dimension (W x D x H)	570 x 650 x 1115 mm	650 (1255)* x 550 x 1820 mm
Weight approx.	110 kg	190 kg
Art. no.	14-2105	14-2108

Standard accessories:

- Drill chuck 16 mm
- 2 pcs. eccentric holder
- Longitudinal fence
- Drill depth stop with scale
- Quick clamping vice
- Mortising chisel 15,87 mm
- Gas pressure balancing cylinder
- Tiltable coordinate table (HM 25 TOP)
- Tiltable working table (HM 30 Porta)
- Closed machine base with tool shelf (HM 30 Porta)

* with longitudinal fence

Chisel mortising machine

HM 30 Porta

Drilling, multi-boring
and chisel mortising

The HM 30 Porta mortising machine features a solid construction and wide range of accessories, making it ideal for processing of large workpieces, such as doors, window frames etc. This model can be used for individual as well as repeated operations.

- Powerful drive motor, also suitable for continuous operation
- Adjustable eccentric clamp secure workpiece to table
- Ideal for mortising of rectangular shaped holes for tenon joints and more
- Optimal device for slotting and mortising of hard and soft timbers
- Adjustable drill depth stop for high repeat accuracy when mortising
- Includes gas pressure cylinder to support mortising

BERNARDO
PROFESSIONAL



Solid work table tilts 45° to the right and left.



Cross and longitudinal movement feature adjustable fences.

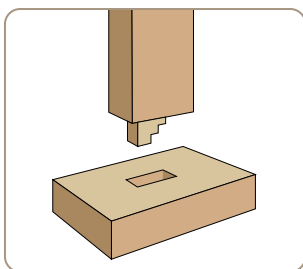

Example of use: tenon joints



Example of use.



Choice of drill heads are optionally available.

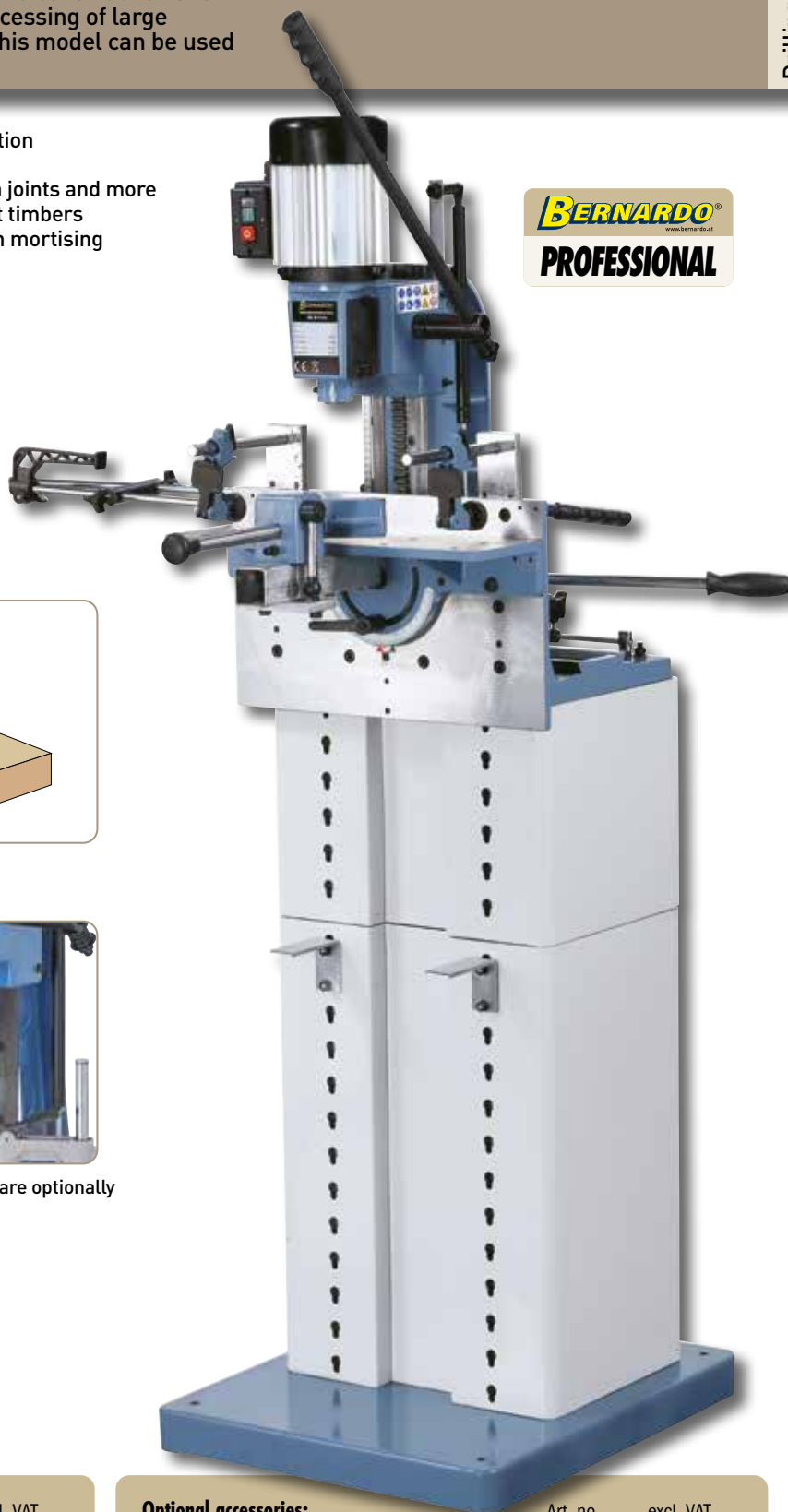

Optional accessories:

Mortising chisel 6,35 mm, 19 mm shaft
Mortising chisel 8,00 mm, 19 mm shaft
Mortising chisel 9,50 mm, 19 mm shaft
Mortising chisel 12,70 mm, 19 mm shaft
Mortising chisel 15,87 mm, 19 mm shaft
Mortising chisel 19,00 mm, 19 mm shaft

Art. no.	excl. VAT
14-1000	
14-1001	
14-1002	
14-1003	
14-1004	
14-1005	

Optional accessories:

Mortising chisel 25,40 mm, 19 mm shaft
Gang drill head 32 mm
Drill head 43 mm for window handle
Drill head 42/11 for hinge type Grass
Drill head 45/9,5 for hinge type Blum
Stand for HM 25 TOP

Art. no.	excl. VAT
14-1006	
14-1106	
14-1104	
14-1110	
14-1112	
14-2095	

Mortising machine

LBM 150 P

- Complete with Westcott drill chuck 0 – 16 mm with cover
- Eccentric holder for secure fastening of workpiece comes standard
- Ergonomically positioned lever allows for one handed operation of work table
- Motor protective switch in accordance with IP 54 standards with undervoltage release
- Precise roller guiding ensure accurate movement of work table
- Powerful motor guarantees optimal performance
- Multiple holes are easy to achieve with the rotor group (part of standard equipment)



Complete with 4-size rotor group with grid spacing 16 / 20 / 22 / 25 mm.



Emergency-off button and rotation switch on machine side.



Set height of work table can be read out on scale.



Practical tool shelf in machine base.



Optionally available universal trolley allows for easy transport.

Technical data	LBM 150 P
Table size	500 x 200 mm
Table height	760 - 900 mm
Max. drill depth 90°	150 mm
Drill width	300 mm
Height adjustment	140 mm
Speed	2850 rpm
Westcott drill chuck	0 - 16 mm
Dust extraction outlet	100 mm
Motor power output S1100%	2,2 kW (3,0 HP)
Motor power input S6 40%	3,0 kW (4,0 HP)
Voltage	230 V or 400 V
Machine dimension (B x T x H)	770 x 920 x 1245 mm
Weight approx.	102 kg
Art. no.	10-0998 (230 V) 10-0999 (400 V)

Standard accessories:

- 4-size rotor group with grid spacing 16 / 20 / 22 / 25 mm
- Westcott drill chuck 0 - 16 mm
- 1 pc. eccentric holder
- Mitre fence with guide
- Left and right turning
- Digital readout for table height adjustment
- Machine base with tool shelf

The LBM 150 P is a low cost mortising machine features right and left turning, a mitre fence as well as a 4-size rotor group. The small but compact construction makes this model ideal for craftsmen.

LBM 150 P

Drilling, multi-boring
and chisel mortising



Complete with eccentric holder to allow secure fastening of workpiece.



Adjustable mitre fence, tilttable 2 x 60°.



Handwheel allows for smooth height adjustment of work table.

Digital readout for table height adjustment

Right-left turning



VOLTAGE

Alternatively in
230 V or 400 V

Optional accessories:

	Art. no.	excl. VAT
Mortising bit set 6 pcs. clockwise (6/8/10/12/14/16 mm), 13 mm shaft	16-2002	
Mortising bit set 6 pcs. counter clockwise (6/8/10/12/14/16 mm), 13 mm shaft	16-2003	
Dust collector DC 230 E / 230 V with tube (2,5 m)	12-2043	

Optional accessories:

	Art. no.	excl. VAT
Dust collector DC 230 E / 400 V with tube (2,5 m)	12-2044	
PVC-tube diam. 100 mm (4 m)	12-1069	
Automatic start-up ALV 2 / M 230 - 230 V	12-1152	
Automatic start-up ALV 10 / 1 M	12-1150	
Universal carriage MB 230	56-10700	

BERNARDO[®]
www.bernardo.at

For your closest dealer, contact us at www.bernardo.at

Mortising machine

LBM 220

- Equipped with 2 pcs. eccentric holder and mitre fence
- Advantage of drill unit travel: combined with the serially table extension, longer, large workpieces such as doors, can be processed effortlessly
- One hand lever allows for easy adjustment of cross support
- Westcott drill chuck 0 – 20 mm with protective cover comes standard
- Includes mortising chisel collet for accurate mortising of rectangular holes (eg. tenon joints)
- Handwheel allows for convenient height adjustment of drill unit
- Rigid steel construction eliminates vibrations
- Powerful motor ensures optimal performance
- Large grey cast-iron table features treated surface
- Equipped with 2 speed settings plus right and left turning device
- Rotor group with grid spacing 16 / 20 / 22 / 25 mm comes standard, ideal for multiple hole drilling



Rotor group with grid spacing 16 / 20 / 22 / 25 mm includes remote lever to set spacing, ideal for multiple hole drilling.

Right-left turning



Precise roller guiding allows accurate movement of drill unit.

BERNARDO
www.bernardo.at
SEMI-PROFESSIONAL

VOLTAGE

Alternatively in
230 V or 400 V

Technical data	LBM 220
Table size	570 x 300 mm
Table enlargement (optional)	2x 600 x 260 mm
Table extension (optional)	300 x 600 mm
Table height	870 mm
Max. drill depth	155 mm
Drill width	300 mm
Height adjustment	160 mm
Speed	1400 / 2800 rpm
Westcott drill chuck	0 - 20 mm
Motor power output S ₁ 100%	3,0 kW (4,0 HP)
Motor power input S ₆ 40%	4,2 kW (5,7 HP)
Voltage	230 V or 400 V
Machine dimension (W x D x H)*	570 x 950 x 1340 mm
Weight approx.	140 kg
Art. no.	10-10040 (230 V) 10-1004 (400 V)

* with table enlargement and extension: 2500 x 1500 x 1340 mm

Serially table extensions in width and length allow processing of large workpieces.

Standard accessories:

- Table enlargement and extension
- 4-size rotor group with grid spacing 16 / 20 / 22 / 25 mm
- Westcott drill chuck 0 - 20 mm
- 1 pc. mortising chisel 9,50 mm
- 2 pcs. eccentric holder
- Mitre fence with guide
- Left and right turning
- 4 mortising chisel collets (19, 20, 28, 30 mm shaft)
- Machine base with tool shelf

The LBM 220 mortising machine features a torsion-free steel construction and a firmly attached, surface treated, amply sized grey cast-iron table. The serially table extension and enlargement allow for large workpieces to be processed.

LBM 220

Drilling, multi-boring and chisel mortising



For angular drilling this machine comes with a mitre fence which tilts to both sides (-60° to +60).



Westcott drill chuck is suitable for mortising bits with 20 mm shaft size.



Comes complete with counter weight to make this model also suitable for mortising chisels with a diameter of up to 25.4 mm.

Fully equipped with 2 speed settings



Optional accessories:

	Art. no.	excl. VAT
Mortising bit set 6 pcs. clockwise (6/8/10/12/14/16 mm), 13 mm shaft	16-2002	
Mortising bit set 6 pcs. counter clockwise (6/8/10/12/14/16 mm), 13 mm shaft	16-2003	
Mortising bit 18 mm, clockwise, 16 mm shaft	16-2004	
Mortising bit 20 mm, clockwise, 16 mm shaft	16-2005	
Mortising bit 22 mm, clockwise, 16 mm shaft	16-2006	
Mortising chisel 6,35 mm, 19 mm shaft	14-1000	

Optional accessories:

	Art. no.	excl. VAT
Mortising chisel 8,00 mm, 19 mm shaft	14-1001	
Mortising chisel 9,50 mm, 19 mm shaft	14-1002	
Mortising chisel 12,70 mm, 19 mm shaft	14-1003	
Mortising chisel 15,87 mm, 19 mm shaft	14-1004	
Dust collector DC 230 E / 400 V with tube (2,5 m)	12-2044	
Dust collector DC 300 / 400 V	12-2045	
Tube diam. 100 mm (6 m)	12-1077	
Automatic start-up ALV 10 / 1 M	12-1150	

Staircases works and mortising machine

LBM 350 T

- Maintenance-free linear guiding allows for feed of drill depth
- Quick lift system allows for efficient, economical processing without time-consuming winding of crank
- Smooth, stepless height setting of drill head features fine adjustment and gas pressure cylinder for counter balance
- Cross travel and height adjustment features scales and adjustable fences
- Robust steel construction eliminates vibrations
- Drill depth adjustable via scale and fence
- Height adjustment of drill head can be altered throughout vertical slotting
- Large grey cast iron table with polished surface



Powerful 2-step motor ensures optimal performance.



Drill head tilts 60° to right and left.



Drill table features scale with zero marking in the middle.

**Ideal for staircases
and frame works**

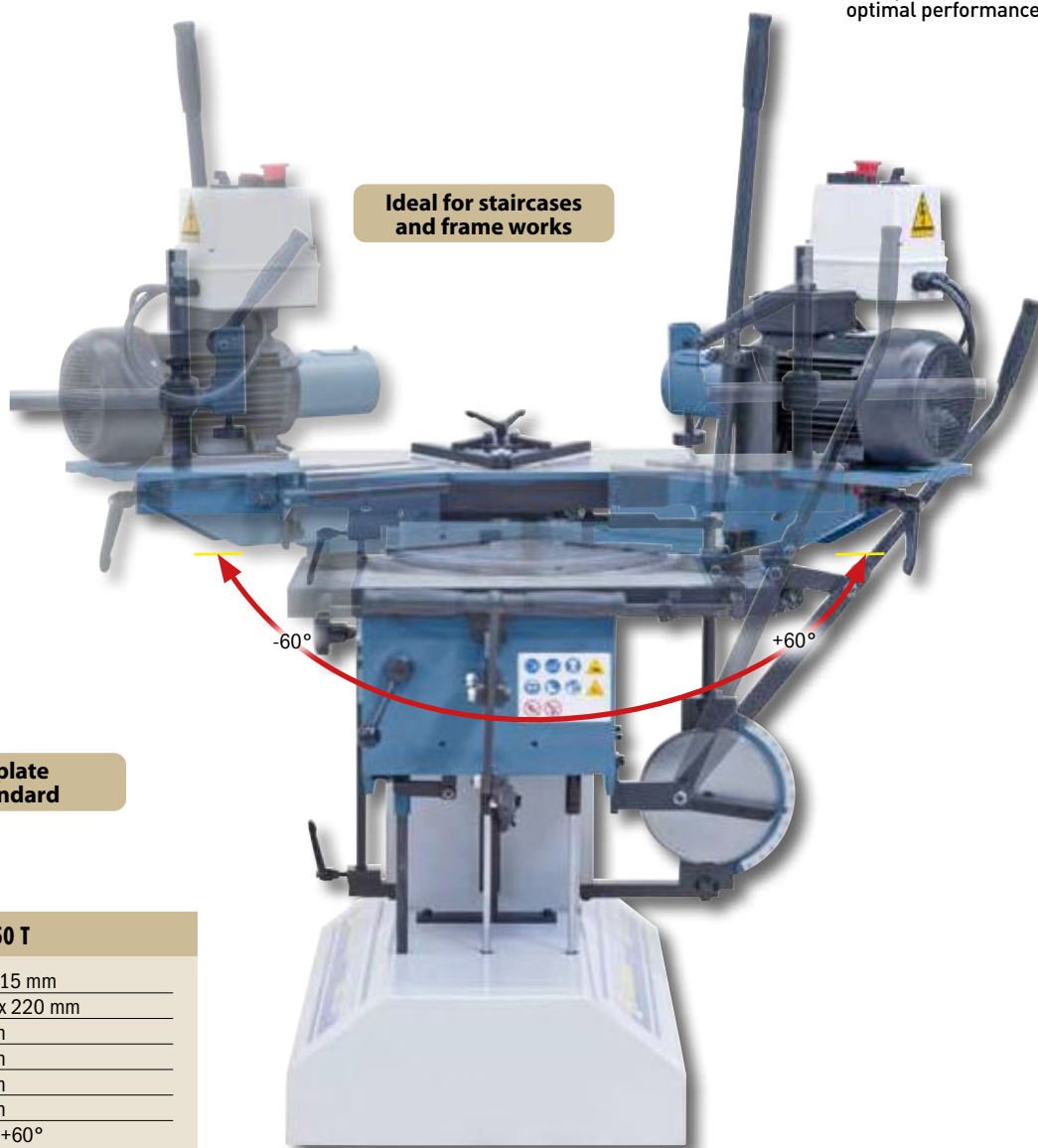

**Drill template
comes standard**

Technical data	LBM 350 T
Table size	595 x 315 mm
Table extension	2x 200 x 220 mm
Table height	830 mm
Max. drill depth	220 mm
Drill width	340 mm
Height adjustment	145 mm
Drill head tiltable right / left	-60° to +60°
Speed	1400 / 2850 rpm
Westcott drill chuck	0 - 20 mm
Motor power	1,5 / 1,9 kW (2,0 / 2,6 HP)
Voltage	400 V
Machine dimension (W x D x H)	1200 x 1050 x 1300 mm
Weight approx.	240 kg
Art. no.	10-1011

Standard accessories:

- 2 pcs. eccentric holder
- 2 pcs. table extension
- Adjustable double mitre fence (30° - 90°)
- Template device

The top model of the LBM range features a drill head tilting 60° to the right and left, making it the perfect solution for assemblies around staircases, window and frame works. The motor is moved single handed and the work table is mounted firmly which allows for processing of large workpieces such as doors for example.

LBM 350 T

Drilling, multi-boring and chisel mortising



Includes double mitre fence steplessly adjustable from 30° - 90°.



Complete with template for drilling of bevelled slots.



Guide for height setting precisely adjustable.



Fully equipped with 2 speed settings

BERNARDO
PROFESSIONAL

Optional accessories:

	Art. no.	excl. VAT
Mortising bit set 6 pcs. clockwise (6/8/10/12/14/16 mm), 13 mm shaft	16-2002	
Mortising bit 18 mm, clockwise, 16 mm shaft	16-2004	
Mortising bit 20 mm, clockwise, 16 mm shaft	16-2005	
Mortising bit 22 mm, clockwise, 16 mm shaft	16-2006	

Optional accessories:

	Art. no.	excl. VAT
Baluster drill 20 mm, 13 mm shaft	16-2020	
Baluster drill 22 mm, 13 mm shaft	16-2021	
Baluster drill 25 mm, 13 mm shaft	16-2022	
Baluster drill 30 mm, 13 mm shaft	16-2023	

Universal multiboring machine

Multibor DB 21

- Automatic drill unit return when reaching set drill depth
- Includes fittings for multiple hole drilling up to 280 mm, ideal for multiple hole drilling eg. Side panels, sliding door cupboards and many more
- Adjustable feed rate allows clean perforation of holes
- Drill unit adjustable to 45° angle for mitre corpus-dowelling
- Mechanical digital display allows drill height adjustment over support table
- Automatic pneumatic control with foot pedal for clamping – drilling – releasing
- Reliable end stop system allows for short conversion times



Keyless drill chuck is part of standard equipment



Removable side fences allow for short conversion times from corpus to frame and multiple hole boring

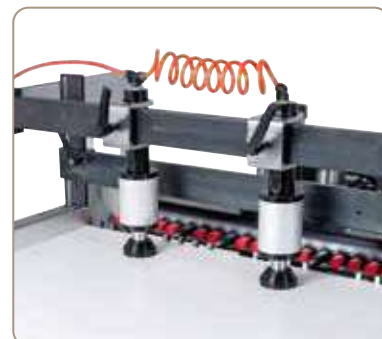

Pneumatic clamp adjustable for drilling of smaller workpieces



For manufacturing from:

- Multiple hole boring
- Frames
- Corpus connectors
- Frame connection
- 45° connections
- 90° connections
- Hardware drilling



Fence with 3 gaps to use with multiple drill heads for hinges

Technical data

Multibor DB 21

Spindles	21 pcs.
Distance between spindles	32 mm
Distance first / last spindle	640 mm
Max. drill depth	50 mm
Table size	870 x 560 mm
Spindle speed	2800 rpm
Motor power	1,5 kW
Voltage	400 V
Air pressure	6 - 8 bar
Machine dimension (W x D x H)	1100 (3000*) x 1130 x 1300 mm
Weight approx.	370 kg
Art. no.	10-1030

* with optional aluminium fence

Standard accessories:

- 2 pcs. pneumatic clamping cylinder
- 4 pcs. keyless drill chuck
- Pneumatic tilting of the drill head
- Mechanical digital readout of drill depth
- Mechanical digital readout for drill depth over support table
- 2 pcs. side fence with stops
- Foot pedal

The Multibor DB 21 universal multiboring machine features 21 spindles, making it perfect for drilling corpus connections, frames and hardware and multiple hole boring. The pneumatic tiltable drill unit guarantees short conversion times making this model universal in use and attractive in price and benefit.

Multibor DB 21

Drilling, multi-boring
and chisel mortising



Includes two counters:
for drill depth and
height adjustment



Pneumatic drill unit tilt from 0° - 45° - 90°



Pneumatic tilting
of drill unit

Optional accessories:

	Art. no.	excl. VAT
Aluminium fence 3000 mm with 4 stops	10-1031XL	
Keyless drill chuck	10-1032	
Combi bit segment Super 43/0 f. concealed hinges Grass	14-1121	

Optional accessories:

	Art. no.	excl. VAT
Combi bit segment Super 43/0 f. concealed hinges Blum 14-1122		
Tap borer		on request

Your dealer

ORPI SL

C/ Juan de la Cierva, 23
50014 Zaragoza

Tlfn: 976 471 440

www.orpi-sl.com orpi@orpi-sl.com

BERNARDO[®]
www.bernardo.at

PWA Handelsges.m.b.H.

4020 Linz | Nebingerstraße 7a | Austria
phone: +43.732.66 40 15 | fax: +43.732.66 40 15-9
e-mail: bernardo@pwa.at | www.bernardo.at

Imprint:

All rights reserved – reproduction of images or texts or parts of these is strictly prohibited unless prior arrangements are made. Subject to technical and optical amendments. Product specifications subject to change without notice. Not responsible for printing errors or mistakes. Machines are partly displayed with optional extras. Prices subject to change. Prices in Euros, ex works (Linz, Austria), excl. any taxes. Edition 01/2024.