

# **BERNARDO**®

www.bernardo.at

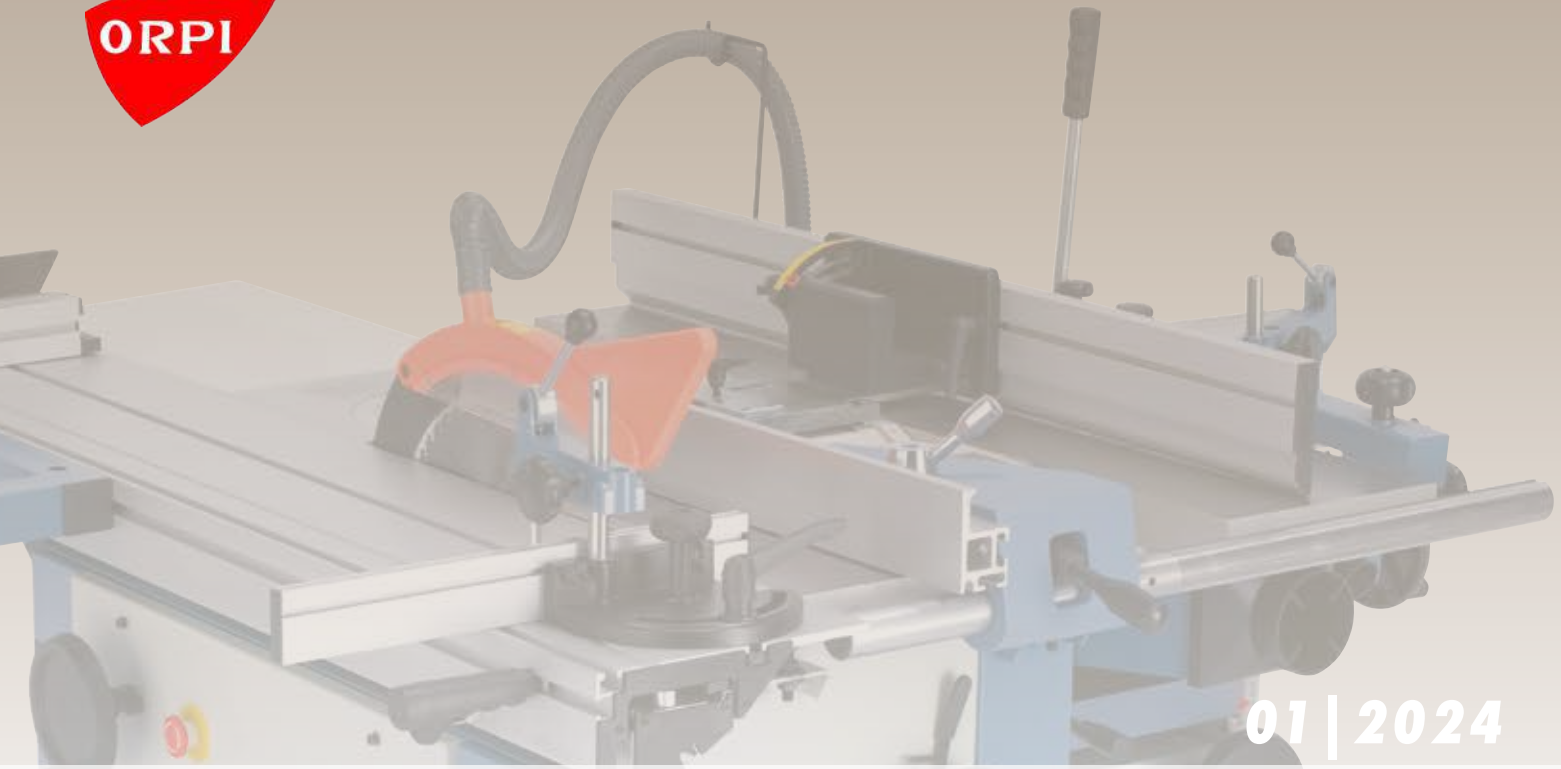

01 | 2024

## **COMBINED MACHINES**



- CWM 250 R
- CWM 250 Top
- CWM 150
- FK 200 R
- FK 250 F
- CSM 1600
- CSM 2000
- CSM 2600
- PSM 2000
- PSM 2600
- CWM 260 F - 1200
- CWM 260 F - 1600
- CWM 310 F - 2000
- CU 250 F - 1600
- CU 310 F - 2000
- CU 310 F - 2600
- CF 310 F - 2600
- CF 410 F - 2600

# Universal combined machine

# CWM 150

The CWM 150 is a handy, universal combi-machine offering a large range of applications: planing, thicknessing, sawing, milling, drilling. The small and compact construction makes this model ideal for amateurs.

- Precisely-bedded 2-knife cutterblock with HSS knives
- Aluminium sliding table complete with mitre fence
- All switches are clearly arranged on control panel
- Numerous applications on little space
- All aluminium parts (sliding table, fences etc.) are anodized
- Ideal price-to-performance ratio for amateurs and craftsmen
- Ideal for accurate planing of boards, panels, planks etc.

Sliding table features T-slot for mounting of mitre fence.



Mortising unit, a necessity for slotting and drilling, is part of standard equipment.



## Technical data

## CWM 150

### Planer

Planing width	155 mm
Table length	615 mm
Table height	845 mm
Shaft rotation speed	6000 rpm
Cutter knives	2 pcs.
Planer shaft diameter	45 mm
Planer fence	735 x 100 mm
Fence tiltable	90° to 45°
Max. cutting depth	1,5 mm

### Thicknesser

Table length	310 mm
Working width	150 mm
Working thickness, min/max.	10 - 92 mm
Max. cutting depth	1,0 mm
Feed speed	7,0 m/min
Dust extraction outlet	50 mm

### Circular saw

Table size	420 x 615 mm
Table height	845 mm
Sliding table	745 x 120 mm
Cutting length	510 mm
Max. sawblade diameter	200 x 30 mm
Max. cutting height 90°	65 mm
Cutting width on rip fence	370 mm
Speed main sawblade	4200 rpm
Dust extraction outlet	60 mm

### Spindle moulder

Height adjustment	45 mm
End mill collet	6, 8, 12 mm
Spindle speed	9000 rpm

### Mortising unit

Table size	260 x 125 mm
Drill collet	6, 8, 10 mm
Max. drill depth	45 mm
Drill width	95 mm
Height adjustment	60 mm

Motor power	1,0 kW (1,36 HP)
Voltage	230 V
Machine dimension (W x D x H)	900 x 800 x 1000 mm
Weight approx.	49 kg
Art. no.	08-1249



Planer fence runs along side, tiltable from 90° to 45°.



## Standard accessories:

- Planer knives 157 x 17 x 3 mm
- Planer fence
- Mortising unit
- Downholder
- Mitre fence
- Sliding table
- Moulding fence
- Carbide sawblade 200 x 2,6 x 30 mm / 20T
- Protective cover with dust extraction outlet
- Connector tube with Y-piece
- Stand
- Push stick
- Tools

**BERNARDO**  
www.bernardo.at  
**HOBBY**

# Circular saw & spindle moulder

# FK 200 R

The FK 200 R circular saw & spindle moulder comes complete with a roller table.  
The small and compact construction makes this model ideal for amateurs.

- Optimal price-to-performance ratio for amateurs and craftsmen
- Solid moulding fence with dust port of 100 mm
- Ergonomically arranged switches and control elements allow for high work comfort
- Solid, grey cast-iron table eliminates vibrations, constructed and polished with precision
- Practically positioned handwheels allow for convenient saw unit adjustment
- Roller table with aluminium fence ensures high user comfort
- Emergency stop button on front of machine increases safety
- Most suitable for accurate processing of panels, planks, boards etc.
- Dynamically balanced moulder spindle ensures for vibration-free run



The fences of moulding fence can easily and quickly be adjusted to different cutters. Part of the standard equipment is a protective device to avoid kickback of workpieces.



Grey, cast-iron roller table constructed and polished with top accuracy.



For angular cutting the sawblade can be tilted from 90° to 45°.

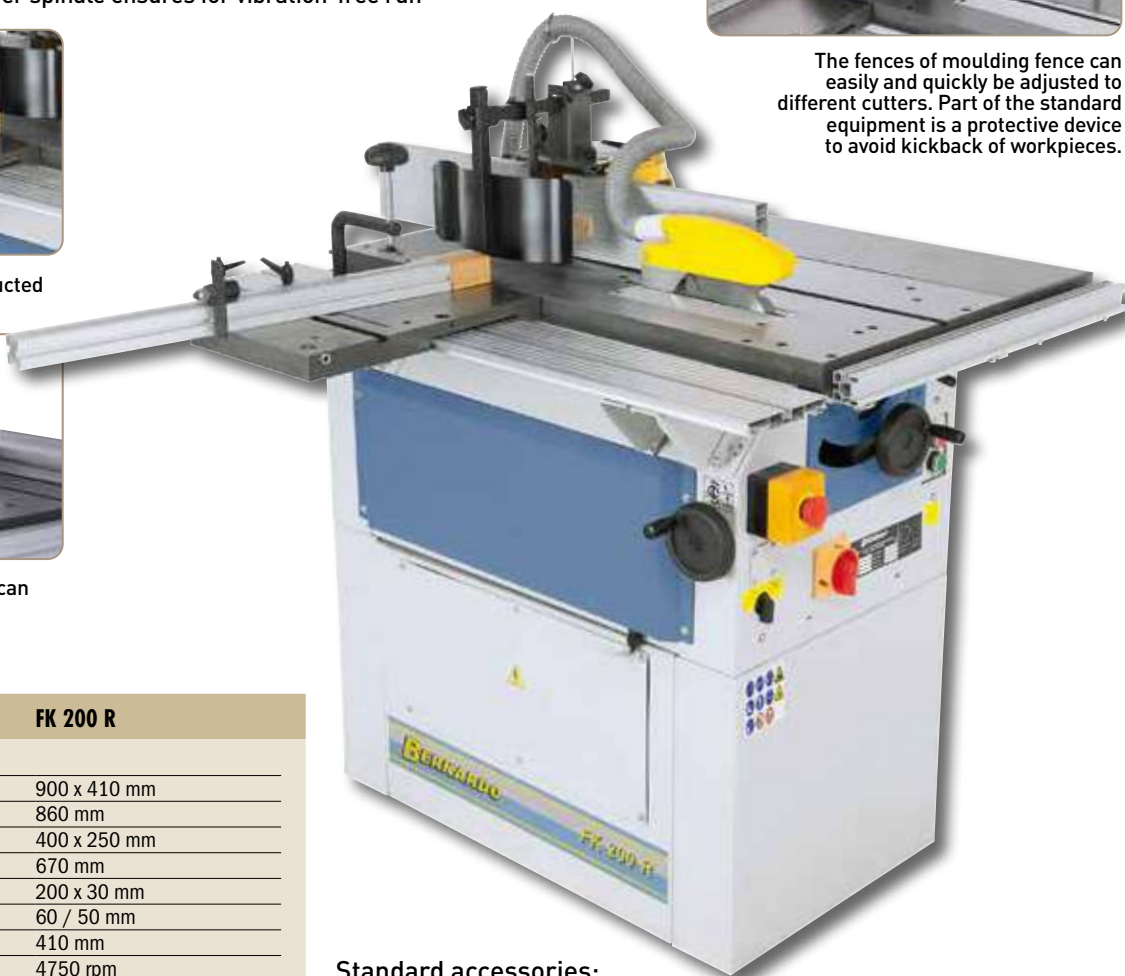

## Technical data

## FK 200 R

### Circular saw

Table size	900 x 410 mm
Table height	860 mm
Roller table	400 x 250 mm
Cutting length	670 mm
Max. sawblade diameter	200 x 30 mm
Max. cutting height 90° / 45°	60 / 50 mm
Cutting width on rip fence	410 mm
Speed main sawblade	4750 rpm
Dust extraction outlet	100 mm
Motor power output S <sub>1</sub> 100%	1,1 kW (1,5 HP)
Motor power input S <sub>6</sub> 40%	1,5 kW (2,0 HP)

### Spindle moulder

Spindle diameter	30 mm
Height adjustment	100 mm
Table opening	145 mm
Working length of spindle	70 mm
Max. tool diameter	
- at profiling	140 mm
- at tenoning	140 mm
Spindle speed	6500 rpm
Motor power output S <sub>1</sub> 100%	1,4 kW (1,9 HP)
Motor power input S <sub>6</sub> 40%	2,0 kW (2,7 HP)
Voltage	400 V
Machine dimension (W x D x H)	1200 x 1190 x 1120 mm
Weight approx.	140 kg
Art. no.	08-1169

## Standard accessories:

- Mitre fence
- Downholder
- Connector tube with Y-piece
- Carbide sawblade 200 x 3,0 x 30 mm / 18T
- Protective cover with dust extraction outlet
- Aluminium fence with stop
- Roller table
- Table extension
- Moulding fence
- Push stick
- Tools

## Optional accessories:

Carbide sawblade 200 x 3,0 x 30 mm / 20T	17-1117
Universal cutter head set 100 x 40 x 30 mm	16-2349
Dust collector DC 200 E / 230 V with tube (2,0 m)	12-2039
Dust collector DC 230 E / 400 V with tube (2,5 m)	12-2044
Automatic start-up ALV 2 / M 230 - 230 V	12-1152



Art. no.	excl. VAT
17-1117	
16-2349	
12-2039	
12-2044	
12-1152	

# Circular saw and spindle moulder

# FK 250 F

- Extractable telescopic fence mountable at front or rear of square table
- Solid square table for sufficient support when processing large panels
- Amply sized, robust, grey cast-iron table eliminates vibrations
- Spindle moulder unit features 3 different speeds (3500 / 5500 / 7000 rpm)
- Smooth running, precise sliding table features hardened, prism-shaped guides
- Ergonomically arranged handwheels for convenient adjustment of saw unit
- Complete with telescopic arm and longitudinally adjustable square table
- Moulding fence equipped with fine adjustment on both sides
- Scoring unit and sawblade are part of standard equipment

**Best Price**

Serially with scoring unit



Technical data	FK 250 F
<b>Circular saw</b>	
Table size	1045 x 300 mm
Table height	850 mm
Table extension	300 x 245 mm
Table enlargement	1045 x 500 mm
Square table	410 x 600 mm
Sliding table	1200 x 240 mm
Cutting length	1350 mm
Max. sawblade diameter	254 x 30 mm
Max. cutting height 90° / 45°	65 / 55 mm
Cutting width on rip fence	700 mm
Speed main sawblade	4050 rpm
Speed scoring sawblade	6300 rpm
Scoring sawblade	80 x 20 mm
Dust extraction outlet	100 mm
Motor power output S <sub>1</sub> 100%	3,0 kW (4,0 HP)
Motor power input S <sub>6</sub> 40%	4,2 kW (5,7 HP)
<b>Spindle moulder</b>	
Spindle diameter	30 mm
Height adjustment	150 mm
Table opening	150 mm
Working length of spindle	90 mm
Max. tool diameter	
- at profiling	140 mm
- at tenoning	200 mm
Spindle speed	3500 / 5500 / 7000 rpm
Motor power output S <sub>1</sub> 100%	3,0 kW (4,0 HP)
Motor power input S <sub>6</sub> 40%	4,2 kW (5,7 HP)
Voltage	230 V or 400 V
Machine dimension (W x D x H)	1500 x 1560 x 1250 mm
Weight approx.	255 kg
Art. no.	08-1173 (230 V) 08-1174 (400 V)

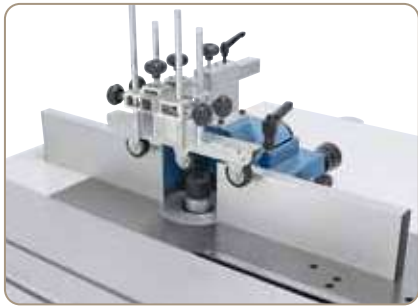

Moulding fence features fence rails made of anodized aluminium.



Control elements are clearly mounted on electronic panel.

**Standard accessories:**

- Sawblade 250 x 3,2 x 30 mm / 24T
- Scoring sawblade 80 x 3,2 x 20 mm / 8T
- Protective cover with dust extraction outlet and tube
- Mitre fence and downholder
- Eccentric holder
- End stop
- Table extension and enlargement
- Extractable telescopic fence
- Square table
- Moulding fence
- Push stick
- Tools

The FK 250 F circular saw & spindle moulder features a sliding table, making this model ideal for experienced craftsmen with high expectations. The extensive range of standard equipment (scoring unit, 3 spindle speeds, sliding table etc.) ensures an optimal price to performance ratio.

# FK 250 F



The moulding fence comes complete with fine adjustment. An integrated dust port allows for proper dust extraction.



Parallel fence features quick and fine adjustment for a cutting width up to 700 mm.



Sawblade cover with integrated dust port positioned at riving knife. Scoring unit is part of equipment.



Sawblade angle can easily be read out on scale.



The torsion-free square table assists when cutting large panel.

### VOLTAGE

Alternatively in 230 V or 400 V

### OPTIMUM

3 spindle speeds

#### Optional accessories:

Set of sawblades (3 pcs.) 250 mm, in aluminium case  
 Scoring sawblade 80 x 20 x 3 mm  
 Universal cutter head set 100 x 40 x 30 mm  
 Dust collector with cartridge filter DC 250 CF / 230 V  
 Dust collector DC 400 / 400 V

Art. no.	excl. VAT
17-1651	
17-1602	
16-2349	
12-2085	
12-2060	

# Circular saw and spindle moulders

# CSM 1600 CSM 2000

- Handwheel on front of machine allows for height adjustment of milling spindle, easy to read on scale
- Powerful motor guarantees optimal cutting capacity even at continuous operation
- Square table with roller for convenient handling of larger workpieces
- Extractable telescopic fence (up to 2260 mm), mountable at front or rear of square table
- Telescopic-longitudinal fence comes complete with end stop feat. fine adjustment
- All aluminium parts (sliding table, fences,...) are anodized
- LED speed display guarantees easy read-out
- Aluminium sliding table features hardened guide rails

**Solid construction**



Sawblade can be tilted from 90° to 45° for angular cutting. Mitre fence can be used for cuts up to 60°.

**Best price**

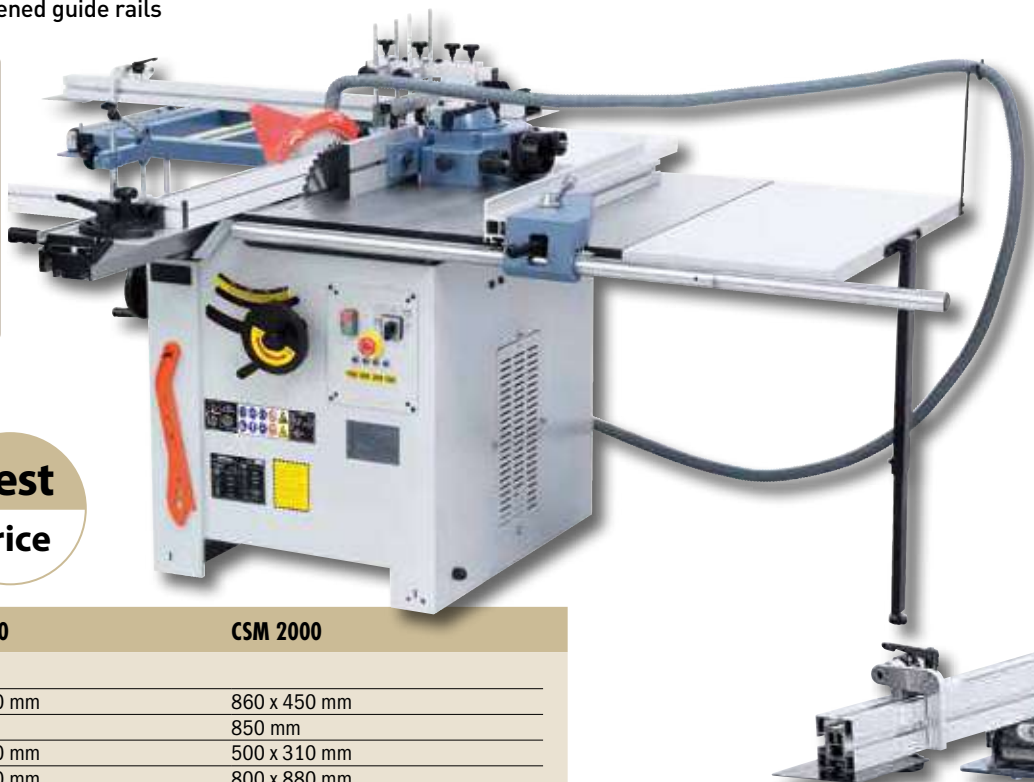

Technical data	CSM 1600	CSM 2000
<b>Circular saw</b>		
Table size	860 x 450 mm	860 x 450 mm
Table height	850 mm	850 mm
Table extension	500 x 310 mm	500 x 310 mm
Table enlargement	800 x 880 mm	800 x 880 mm
Square table with roll	750 x 580 mm	750 x 580 mm
Sliding table	1600 x 270 mm	2000 x 270 mm
Cutting length	1600 mm	2000 mm
Max. sawblade diameter	315 x 30 mm	315 x 30 mm
Max. cutting height 90° / 45°	100 / 80 mm	100 / 80 mm
Cutting width on rip fence	1270 mm	1270 mm
Speed main sawblade	4500 rpm	4500 rpm
Speed scoring sawblade	8500 rpm	8500 rpm
Scoring sawblade	2-100 x 20 mm	2-100 x 20 mm
Dust extraction outlet	100 mm	100 mm
Motor power output S <sub>1</sub> 100%	2,8 kW (3,8 HP)	2,8 kW (3,8 HP)
Motor power input S <sub>6</sub> 40%	3,9 kW (5,3 HP)	3,9 kW (5,3 HP)
<b>Spindle moulder</b>		
Spindle diameter	30 mm	30 mm
Height adjustment	100 mm	100 mm
Table opening	80 / 100 / 140 / 190 mm	80 / 100 / 140 / 190 mm
Working length of spindle	100 mm	100 mm
Max. tool diameter		
- at profiling	180 mm	180 mm
- at tenoning	200 mm	200 mm
Spindle speed	1800 / 3000 / 6000 / 9000 rpm	1800 / 3000 / 6000 / 9000 rpm
Motor power output S <sub>1</sub> 100%	2,8 kW (3,8 HP)	2,8 kW (3,8 HP)
Motor power input S <sub>6</sub> 40%	3,9 kW (5,3 HP)	3,9 kW (5,3 HP)
Voltage	400 V	400 V
Machine dimension (W x D x H)	1600 x 3010 x 1250 mm	2000 x 3010 x 1250 mm
Weight approx.	352 kg	364 kg
Art. no.	08-1180	08-1181

### Standard accessories:

- Carbide sawblade 315 x 3,0 x 30 mm / 40T
- Scoring sawblade 2-100 x 20 mm / 24T
- Protective cover with dust extraction outlet and tube
- Mitre fence with eccentric holder
- End stop
- Table extension and enlargement
- Extractable telescopic fence
- Stop with fine adjustment
- Square table with roller
- Moulding fence
- Sanding sleeve diam. 75 mm
- Protective and pressing device
- Spindle with left and right turning
- LED speed indication
- Push stick
- Tools

The CSM 1600 and CSM 2000 circular saw & spindle moulder with tiltable sawblade and scoring unit as part of the standard accessories, are ideal models for price-conscious users. The wide range of standard equipment allow these models to offer an extraordinary performance and a maximum number of applications.

# CSM 1600 CSM 2000



T-slot in sliding table allows mounting of mitre fence and end stop.



Extractable telescopic fence (up to 2260 mm) with stop featuring fine adjustment.



Aluminium fence rails come with fine adjustment and can easily and quickly be adjusted to each milling tool.

Square table with roll



**BERNARDO**  
SEMIPROFESSIONAL



Handwheel ensures quick and easy height adjustment of milling spindle, easy to read with magnifier.

**Optional accessories:**

	Art. no.	excl. VAT
Scoring sawblade 2-100 x 20 mm	17-1604	
Universal cutter head set 100 x 40 x 30 mm	16-2349	
Set of sawblades (3 pcs.) 315 mm, in aluminium case	17-1653	

**Optional accessories:**

	Art. no.	excl. VAT
PU-tube diam. 100 mm (6 m)	12-1077	
Automatic start-up ALV 10 / 1 M	12-1150	
Dust collector DC 400 / 400 V	12-2060	

# Circular saw and spindle moulder

# CSM 2600

- Solid square table allows processing of large, heavy panel without additional support
- Table extension for cutting width up to 1270 mm is included
- Complete with 4 milling speeds, quick and easy to read on LED
- Moulder fence with anodized fence rails and fine adjustment
- Equipped with table extension and enlargement for sufficient support of large, heavy panel
- Parallel fence tilts and features a 40 mm round rod guiding
- Extractable telescopic fence (up to 2260 mm), can be mounted at front or rear of square table
- Solid parallel fence with magnifier guarantees high user comfort
- Large, grey cast-iron machine table, precisely manufactured and polished



User-friendly arranged switches and control elements, electronic speed display via LED.

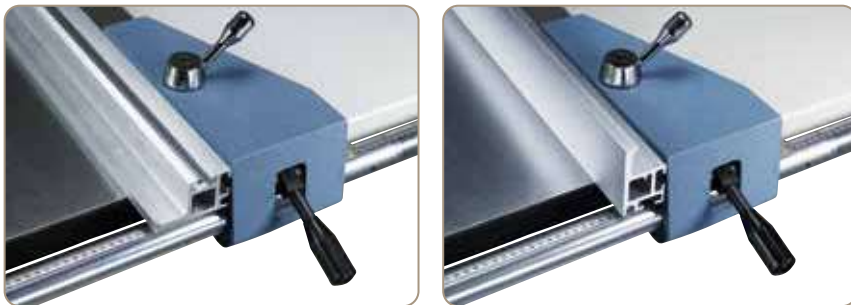

The anodized parallel fence features a uniquely shaped profile and allows viewing of the scale whether using the high or low guide fence.



### Right and left turning of spindle



#### Technical data

#### CSM 2600

##### Circular saw

Table size	860 x 450 mm
Table height	850 mm
Table extension	500 x 310 mm
Table enlargement	860 x 880 mm
Square table with roll	760 x 530 mm
Sliding table	2600 x 270 mm
Cutting length	2600 mm
Max. sawblade diameter	315 x 30 mm
Max. cutting height 90° / 45°	100 / 80 mm
Cutting width on rip fence	1270 mm
Speed main sawblade	4500 rpm
Speed scoring sawblade	8500 rpm
Scoring sawblade	2-100 x 20 mm
Dust extraction outlet	100 mm
Motor power output S <sub>1</sub> 100%	2,8 kW (3,8 HP)
Motor power input S <sub>6</sub> 40%	3,9 kW (5,3 HP)

##### Spindle moulder

Spindle diameter	30 mm
Height adjustment	100 mm
Table opening	80 / 100 / 140 / 190 mm
Working length of spindle	100 mm
Max. tool diameter	
- at profiling	180 mm
- at tenoning	200 mm
Spindle speed	1800 / 3000 / 6000 / 9000 rpm
Motor power output S <sub>1</sub> 100%	2,8 kW (3,8 HP)
Motor power input S <sub>6</sub> 40%	3,9 kW (5,3 HP)
Voltage	400 V
Machine dimension (W x D x H)	2600 x 3090 x 1250 mm
Weight approx.	391 kg
Art. no.	08-1182

#### Standard accessories:

- End stop
- Moulding fence
- Sanding sleeve diam. 75 mm
- Protective and pressing device
- Table extension and enlargement
- Extractable telescopic fence
- Scoring sawblade 2-100 x 20 mm / 24T
- Protective cover with dust extraction outlet and tube
- Mitre fence with eccentric holder
- End stop with fine adjustment
- Square table with roller
- Carbide sawblade 315 x 3,0 x 30 mm / 40T
- LED speed indication
- Spindle with left and right turning
- Push stick
- Tools



# CSM 2600

The CSM 2600 is a combination of sliding saw and spindle moulder, featuring 2 motors, making it an ultimate processing centre for professional users. The robust construction as well as the generous dimensions of this machine create perfect working conditions for cutting solid timber or large material. Even decorative panels can easily be processed by using the scoring unit which is part of standard accessories.



The saw unit, tiltable up to 45°, can be adjusted for a cutting height up to 100 mm, by using the handwheel.



Solid square table with roller for easier handling of large workpieces.

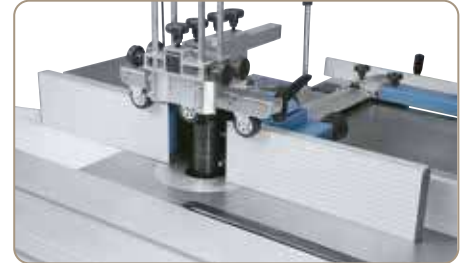

Solid moulding fence features fence rails with fine adjustment.

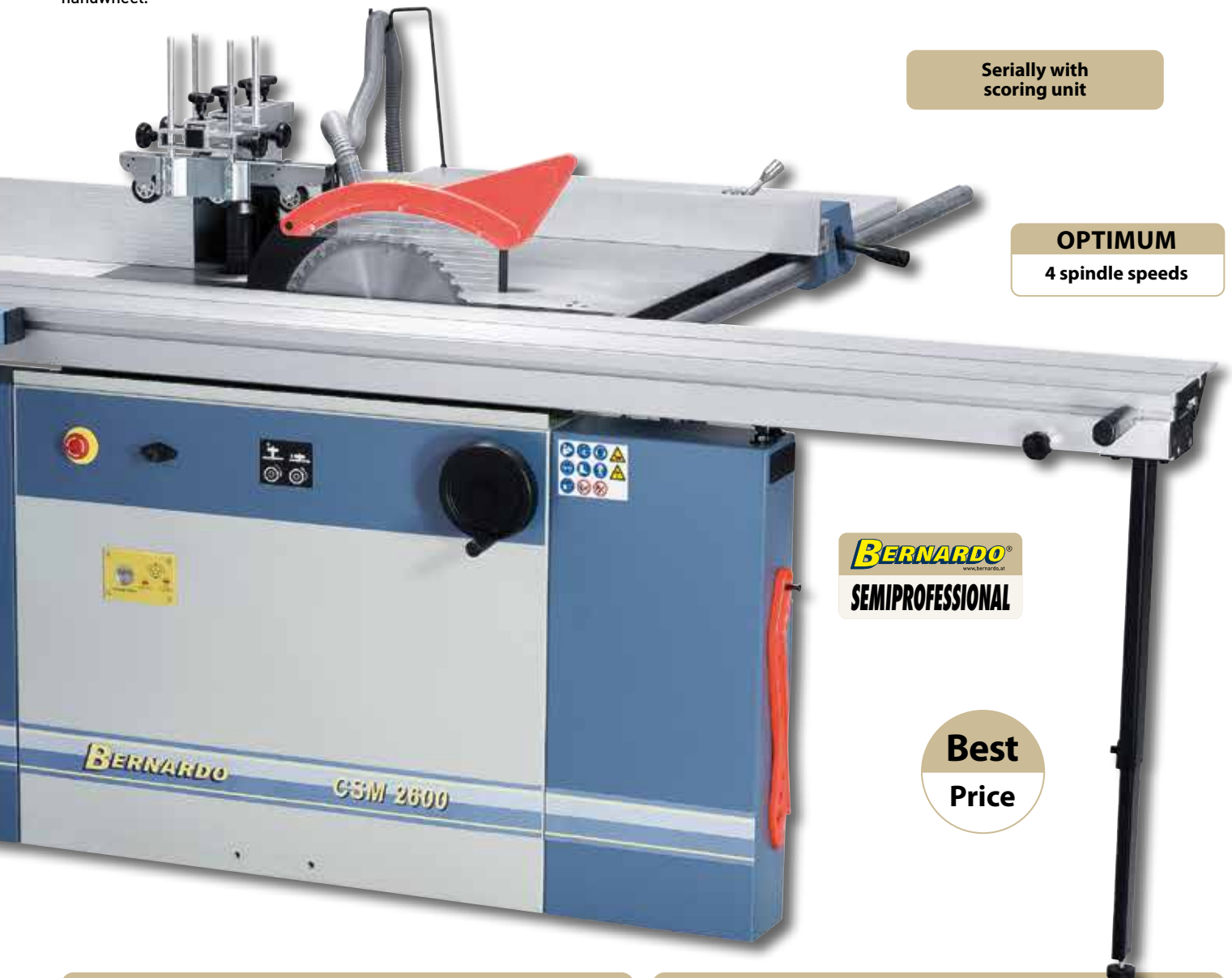

Serially with scoring unit

**OPTIMUM**  
4 spindle speeds

**BERNARDO**  
www.bernardo.at  
**SEMIPROFESSIONAL**

**Best Price**

**Optional accessories:**

Scoring sawblade 2-100 x 20 mm	Art. no.	excl. VAT
Universal cutter head set 100 x 40 x 30 mm	17-1604	
Set of sawblades (3 pcs.) 315 mm, in aluminium case	16-2349	
	17-1653	

**Optional accessories:**

PU-tube diam. 100 mm (6 m)	Art. no.	excl. VAT
Automatic start-up ALV 10 / 1 M	12-1077	
Dust collector DC 400 / 400 V	12-1150	
	12-2060	

# Circular saw and spindle moulders

# PSM 2000 PSM 2600

- Square table with roller for convenient handling of larger workpieces
- Telescopic-longitudinal fence comes complete with end stop feat. fine adjustment
- Quick and easy readout of spindle speed on digital display
- Solid moulding fence features finely adjustable aluminium fence rails
- Large, grey cast-iron moulder unit, tilts from 0° to -45°
- Important feature: Sawblade 315 mm can be used when scoring unit is mounted
- Machine body consists of torsion-free combination of steel and grey cast iron
- Solid square table allows processing of large, heavy panel without additional support



Complete with scoring unit for burr-free operation of panels.



T-slot in sliding table allows mounting of mitre fence and end stop.



Parallel fence with solid round guide (40 mm) can be used for cutting width of up to 1220 mm.

**Right and left turning of spindle**

**Serially with scoring unit**

**OPTIMUM**  
4 spindle speeds



Technical data	PSM 2000	PSM 2600
<b>Circular saw</b>		
Table size	1300 x 380 mm	1300 x 380 mm
Table height	970 mm	970 mm
Table extension	350 x 310 mm	350 x 310 mm
Table enlargement	800 x 880 mm	800 x 880 mm
Square table with roll	940 x 580 mm	940 x 580 mm
Sliding table	2000 x 270 mm	2600 x 270 mm
Cutting length	2000 mm	2600 mm
Max. sawblade diameter	315 x 30 mm	315 x 30 mm
Max. cutting height 90° / 45°	100 / 80 mm	100 / 80 mm
Cutting width on rip fence	1220 mm	1220 mm
Speed main sawblade	4500 rpm	4500 rpm
Speed scoring sawblade	8500 rpm	8500 rpm
Scoring sawblade	90 x 20 mm	90 x 20 mm
Dust extraction outlet	95 mm	95 mm
Motor power output S <sub>1</sub> 100%	3,0 kW (4,0 HP)	3,0 kW (4,0 HP)
Motor power input S <sub>6</sub> 40%	4,2 kW (5,7 HP)	4,2 kW (5,7 HP)
<b>Spindle moulder</b>		
Spindle diameter	30 mm	30 mm
Height adjustment	140 mm	140 mm
Spindle tiltable	0° to 45°	0° to 45°
Table opening	200 mm	200 mm
Working length of spindle	110 mm	110 mm
Max. tool diameter	180 mm	180 mm
Spindle speed	1800 / 3000 / 6000 / 9000 rpm	1800 / 3000 / 6000 / 9000 rpm
Motor power output S <sub>1</sub> 100%	2,8 kW (3,8 HP)	2,8 kW (3,8 HP)
Motor power input S <sub>6</sub> 40%	3,9 kW (5,3 HP)	3,9 kW (5,3 HP)
Voltage	400 V	400 V
Machine dimension (W x D x H)	2000 x 2900 x 1260 mm	2600 x 2900 x 1260 mm
Weight approx.	425 kg	440 kg
Art. no.	08-1185	08-1186

**Standard accessories:**

- End stop
- Moulding fence
- Protective and pressing device
- Table extension and enlargement
- Extractable telescopic fence
- Scoring sawblade 90 x 20 x 3 mm / 13T
- Protective cover with dust extraction outlet and tube
- Mitre fence with eccentric holder
- End stop with fine adjustment
- Square table with roller
- Carbide sawblade 315 x 3,0 x 30 mm / 40T
- Digital speed indication of moulding spindle
- Spindle with left and right turning
- Push stick
- Tools

The PSM-series sliding table saw and spindle moulders are available with a table length of 2000 or 2600 mm. Part of the standard equipment are 2 motors, a sawblade (315 mm) for cutting height up to 315 mm and a scoring unit for smooth processing of coated materials. The wide range of standard equipment allow these models to offer an extraordinary performance and a maximum number of applications.

# PSM 2000 PSM 2600



Electronic display of spindle speed settings.



Milling spindle tilts to the back, bringing several advantages, such as optimal use of the power feed, maximum safety and tidy milling results.



Aluminium fence rails come with fine adjustment and can easily and quickly be adjusted to each milling tool.



**Best  
Price**

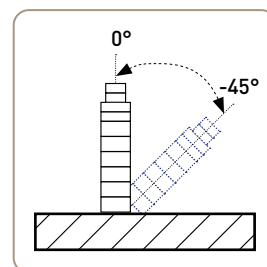

**Optional accessories:**

Scoring sawblade 90 x 20 x 3 mm	Art. no.	excl. VAT
Universal cutter head set 100 x 40 x 30 mm	17-1603	
Set of sawblade (3 pcs.) 315 mm, in aluminium case	16-2349	
	17-1653	

**Optional accessories:**

PU-tube diam. 100 mm (6 m)	Art. no.	excl. VAT
Automatic start-up ALV 10 / 1 M	12-1077	
Dust collector DC 400 / 400 V	12-1150	
	12-2060	

# Universal combined machines

# CWM 250 R CWM 250 Top

- Solid grey, cast-iron table eliminates vibrations, precisely manufactured and polished
- Optional with mortising unit (16 mm capacity) available
- Ergonomically arranged handwheels allow for setting of saw unit
- Equipped with roller table featuring aluminium fence to increase user comfort
- Emergency stop button on front of machine guarantees high level of safety
- Integrated, tiltable dust hood when thickening, extraction outlet 100 mm
- Perfectly suitable for accurate processing of panels, boards, planks etc.
- Dynamically balanced moulder spindle ensures vibration-free run
- Torsion-free planer table made of reinforced grey cast-iron
- Workpiece feed can be switched off when planing

**CWM 250 Top**  
sawblade Ø 250 mm



Solid, up to 45° tiltable planer fence with prism-shaped guide can easily be adjusted.



Grey, cast-iron roller table is precisely manufactured and polished.



Technical data	CWM 250 R	CWM 250 Top	CWM 250 R	CWM 250 Top
<b>Planer</b>			<b>Circular saw</b>	
Planing width	250 mm	250 mm	Table size	900 x 410 mm
Table length	1090 mm	1090 mm	Table height	860 mm
Table height	860 mm	860 mm	Roller table	400 x 250 mm
Shaft rotation speed	4000 rpm	4000 rpm	Cutting length	670 mm
Cutter knives	3 pcs.	3 pcs.	Max. sawblade diameter	200 x 30 mm
Planer shaft diameter	75 mm	75 mm	Max. cutting height 90° / 45°	60 / 50 mm
Planer fence	720 x 130 mm	715 x 130 mm	Cutting width on rip fence	530 mm
Fence tiltable	90° to 45°	90° to 45°	Speed main sawblade	4750 rpm
Max. cutting depth	3 mm	3 mm	Dust extraction outlet	100 mm
Motor power output S <sub>1</sub> 100%	1,5 kW (2,0 HP)	1,5 kW (2,0 HP)	Motor power output S <sub>1</sub> 100%	1,1 kW (1,5 HP)
Motor power input S <sub>6</sub> 40%	2,1 kW (2,8 HP)	2,1 kW (2,8 HP)	Motor power input S <sub>6</sub> 40%	1,5 kW (2,0 HP)
<b>Thickener</b>			<b>Spindle moulder</b>	
Table length	600 mm	600 mm	Spindle diameter	30 mm
Working width	245 mm	245 mm	Height adjustment	100 mm
Working thickness, min./max.	5 - 195 mm	5 - 195 mm	Table opening	145 mm
Max. cutting depth	2,5 mm	2,5 mm	Working length of spindle	70 mm
Feed speed	8 m/min	8 m/min	Max. tool diameter	
Dust extraction outlet	100 mm	100 mm	- at profiling	140 mm
<b>Mortising unit (optional available)</b>			- at tenoning	140 mm
Table size	365 x 145 mm	365 x 145 mm	Spindle speed	6500 rpm
Westcott drill chuck	0 - 16 mm	0 - 16 mm	Motor power output S <sub>1</sub> 100%	1,4 kW (1,9 HP)
Max. drill depth	95 mm	95 mm	Motor power input S <sub>6</sub> 40%	2,0 kW (2,7 HP)
Drill width	140 mm	140 mm	Voltage	230 V or 400 V
Height adjustment	75 mm	75 mm	Machine dimension (W x D x H)	1510 x 1330 x 1120 mm
			Weight approx.	280 kg
			Art. no.	08-1256 (230 V)
				08-1257 (400 V)
				08-1260 (230 V)
				08-1261 (400 V)

The CWM 250 R and CWM 250 Top are versatile universal combi-machines that come complete with a roller table. Model CWM 250 Top features a larger sawblade hence a larger cutting capacity of 75 mm. Compact construction makes these model attractive for craftsmen and amateurs.

# CWM 250 R CWM 250 Top

Combined machines



Solid moulding fence can be used for tools with a diameter of up to 140 mm.

Planer table tilt upright for a simple conversion from planing to thickening in a matter of seconds.



Mortising unit is ideal for drilling oblong, dowel and oblique holes (optionally).

Solid construction



### Standard accessories:

- Cutter knives 250 x 30 x 3 mm
- Planer fence
- Downholder
- Mitre fence
- Roller table
- Moulding fence
- Protective cover with dust extraction outlet
- Connector tube with Y-piece
- Aluminium fence with stop
- Sawblade 200 x 3,0 x 30 mm / 18T (CWM 250 R)
- Sawblade 254 x 3,0 x 30 mm / 36T (CWM 250 Top)
- Push stick
- Tools

**BERNARDO**  
www.bernardo.at  
**HOBBY**

### VOLTAGE

Alternatively in  
230 V or 400 V

### Optional accessories:

Planer knives 250 x 30 x 3 mm, price per pc.	15-1000
Sawblades diam. 250 mm, 3 pcs. (CWM 250 Top)	17-1651
Carbide sawblade 200 x 3,0 x 30 mm / 20T	17-1117
Automatic start-up ALV 2 / M 230 - 230 V	12-1152

Art. no.	excl. VAT
15-1000	
17-1651	
17-1117	
12-1152	

### Optional accessories:

Universal cutter head set 100 x 40 x 30 mm	16-2349
Mortising unit	08-1020
Dust collector DC 230 E / 400 V with tube (2,5 m)	12-2044
Dust collector DC 300 / 400 V	12-2045

Art. no.	excl. VAT
16-2349	
08-1020	
12-2044	
12-2045	

# Universal combined machines

# CWM 260 F - 1200

- Maintenance-free, precisely bedded 3-knife cutterblock with HSS-knives
- Torsion-free, aluminium sliding table with prism-shaped guide
- Both planer tables feature fine adjustment and noise-reducing table lips
- Moulding fence with aluminium fence rails adjustable on both sides
- Moulder unit features 3 speeds for optimal adjustment to the workpiece
- Planer tables tilt into upright position for quick conversion to thicknessing
- All switches are logically arranged on the control panel
- Handwheel with scale allows for tilting of sawblade up to 45°
- Integrated, tiltable dust hood – extraction outlet 100 mm
- Solid aluminium planer fence, tilts 90° to 45°
- Square table in generous size allows for support of larger panel



The fence rails of the moulding fence can easily and quickly be adjusted to various tools. The integrated dust port allows for convenient dust extraction.

Serially with scoring unit

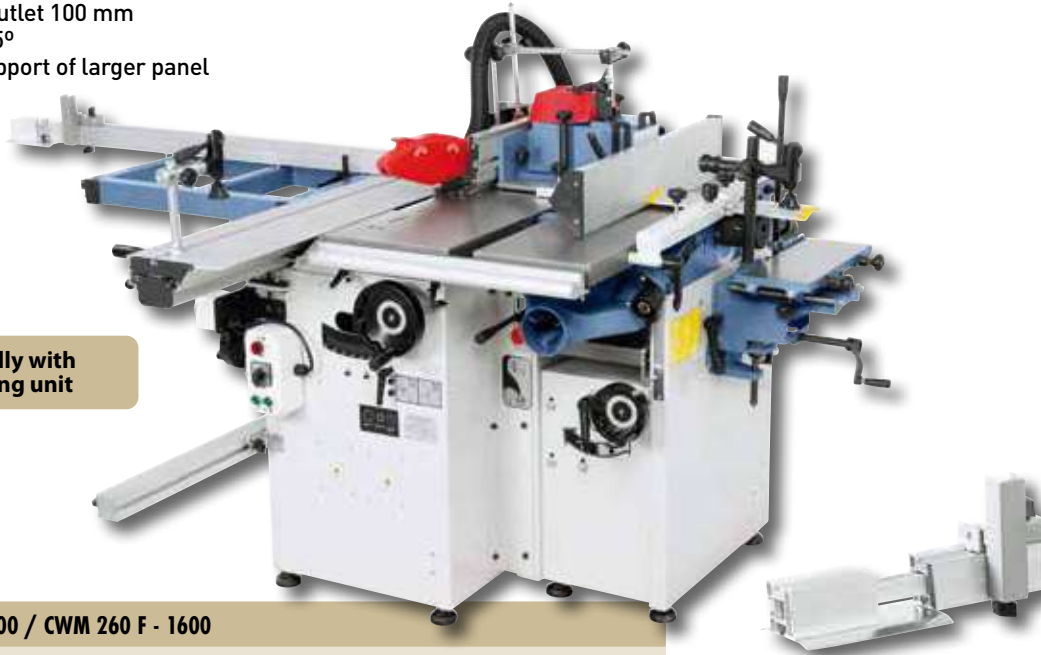

### Technical data

### CWM 260 F - 1200 / CWM 260 F - 1600

Planer		Circular saw	
Planing width	250 mm	Table size	1045 x 300 mm
Table length	1080 mm	Table height	820 mm
Table height	820 mm	Square table	600 x 410 mm
Shaft rotation speed	3750 rpm	Sliding table	1200 x 240 mm / 1600 x 240 mm
Cutter knives	3 pcs.	Cutting length	1300 / 1600 mm
Planer shaft diameter	75 mm	Max. sawblade diameter	250 x 30 mm
Planer fence	700 x 145 mm	Max. cutting height 90° / 45°	65 / 55 mm
Fence tiltable	90° to 45°	Cutting width on rip fence	510 mm
Max. cutting depth	5 mm	Speed main sawblade	4050 rpm
Motor power output S <sub>1</sub> 100%	2,0 kW (2,7 HP)	Speed scoring sawblade	6300 rpm
Motor power input S <sub>6</sub> 40%	2,8 kW (3,8 HP)	Scoring sawblade	80 x 20 mm
<b>Thicknesser</b>		Dust extraction outlet	100 mm
Table length	600 mm	Motor power output S <sub>1</sub> 100%	2,2 kW (3,0 HP)
Working width	250 mm	Motor power input S <sub>6</sub> 40%	3,0 kW (4,0 HP)
Working thickness, min/max.	5 - 190 mm	<b>Spindle moulder</b>	
Max. cutting depth	1,8 mm	Spindle diameter	30 mm
Feed speed	8 m/min	Height adjustment of spindle	150 mm
Dust extraction outlet	100 mm	Table opening	150 mm
<b>Mortising unit</b>		Working length of spindle	90 mm
Table size	370 x 150 mm	Max. tool diameter	
Westcott drill chuck	0 - 16 mm	- at profiling	140 mm
Max. drill depth	105 mm	- at tenoning	200 mm
Drill width	140 mm	Spindle speed	3500 / 5500 / 7000 rpm
Height adjustment	85 mm	Motor power output S <sub>1</sub> 100%	2,2 kW (3,0 HP)
		Motor power input S <sub>6</sub> 40%	3,0 kW (4,0 HP)
		Voltage	400 V
		Machine dimension (W x D x H)	1400 (1620) x 2340 x 1150 mm
		Weight approx.	372 kg / 378 kg
		Art. no.	08-1275 (1200 mm) 08-1276 (1600 mm)



Mortising unit comes complete with large support table and eccentric clamp.

The CWM 260 F universal combi-machine is our entry-level model among our wood processing centres featuring a sliding table.

The machine requires only little space but offers a large range of applications: planing, thicknessing, sawing, milling, drilling. Short conversion times, high user comfort and the choice of a sliding table at 1200 or 1600 mm in length are unbeatable features of this unique model.

# CWM 260 F - 1600



The planer tables tilt into upright position and allow optimal and safe work conditions even when thicknessing short workpieces.



Sawblade cover with integrated dust port connected at riving knife.



Square table can be moved along the entire length of sliding table.



**BERNARDO®**  
www.bernardo.at  
**HOBBY**

**Standard accessories:**

- Cutter knives 250 x 30 x 3 mm
- Planer fence
- Mortising unit
- Westcott drill chuck 0 - 16 mm
- Eccentric holder
- Sawblade 250 x 3,2 x 30 mm / 24T
- Scoring sawblade 80 x 3,2 x 20 mm / 8T
- End stop
- Telescopic fence with stop
- Square table
- Moulding fence
- Push stick
- Protective cover with dust extraction outlet and tube
- Tools

**Optional accessories:**

	Art. no.	excl. VAT
Set of sawblades (3 pcs.) 250 mm, in aluminium case	17-1651	
Scoring sawblade 80 x 20 x 3 mm	17-1602	
Universal cutter head set 100 x 40 x 30 mm	16-2349	
Planer knives 250 x 30 x 3 mm, price per pc.	15-1000	
Mortising bit set 6 pcs. counterclockwise, 13 mm shaft	16-2003	

**Optional accessories:**

	Art. no.	excl. VAT
Planer knives adjustment HML	08-1500	
Dust collector DC 400 / 400 V	12-2060	
PU-tube diam. 100 mm (6 m)	12-1077	
Automatic start-up ALV 10 / 1 M	12-1150	
Lubricant 1 kg, paste	54-1000	

# Universal combined machine

# CWM 310 F - 2000

- Extractable telescopic fence can be mounted at front or rear of square table
- Solid square table allows for sufficient support when processing large panel
- Large, robust grey cast-iron table eliminates vibrations
- Moulder unit comes complete with 3 speed settings (3500 / 5500 / 7000 rpm)
- Smooth, precise sliding table with hardened, prism-shaped guide
- Ergonomically arranged handwheels guarantee convenient adjustment of saw unit
- Planer tables tilt into upright position to allow for quick conversion to thicknessing
- Solid aluminium planer fence, tiltable from 90° to 45°
- Maintenance-free, precisely bedded 3-knife cutterblock features HSS-knives



The moulding fence comes complete with fence rails made of anodized aluminium.



The mortising unit is ideal for oblong, dowel and oblique holes.



## Technical data

## CWM 310 F - 2000

### Planer

Planing width	310 mm
Table length	1300 mm
Table height	835 mm
Shaft rotation speed	4000 rpm
Cutter knives	3 pcs.
Planer shaft diameter	75 mm
Planer fence	1110 x 130 mm
Fence tiltable	90° to 45°
Max. cutting depth	5 mm
Motor power output S <sub>1</sub> 100%	2,2 kW (3,0 HP)
Motor power input S <sub>6</sub> 40%	3,0 kW (4,0 HP)

### Thicknesser

Table length	600 mm
Working width	305 mm
Working thickness, min/max.	5 - 180 mm
Max. cutting depth	2,5 mm
Feed speed	8 m/min
Dust extraction outlet	100 mm

### Mortising unit

Table size	370 x 155 mm
Westcott drill chuck	0 - 16 mm
Max. drill depth	90 mm
Drill width	140 mm
Height adjustment	80 mm

### Circular saw

Table size	1145 x 300 mm
Table height	835 mm
Table extension	240 x 300 mm
Square table	600 x 415 mm
Sliding table	2000 x 240 mm
Cutting length	2240 mm
Max. sawblade diameter	250 x 30 mm
Max. cutting height 90° / 45°	60 / 50 mm
Cutting width on rip fence	520 mm
Speed main sawblade	4050 rpm
Speed scoring sawblade	6300 rpm
Scoring sawblade	80 x 20 mm
Dust extraction outlet	100 mm
Motor power output S <sub>1</sub> 100%	3,0 kW (4,0 HP)
Motor power input S <sub>6</sub> 40%	4,2 kW (5,7 HP)

### Spindle moulder

Spindle diameter	30 mm
Height adjustment	145 mm
Table opening	150 mm
Working length of spindle	100 mm
Max. tool diameter	
- at profiling	140 mm
- at tenoning	200 mm
Spindle speed	3500 / 5500 / 7000 rpm
Motor power output S <sub>1</sub> 100%	3,0 kW (4,0 HP)
Motor power input S <sub>6</sub> 40%	4,2 kW (5,7 HP)
Voltage	400 V
Machine dimension (W x D x H)	2000 x 2500 x 1200 mm
Weight approx.	445 kg
Art. no.	08-1277



The planer tables tilt into upright position to allow for optimal and safe working conditions even when thicknessing short workpieces.

Serially with  
3 spindle speeds

Serially with  
scoring unit



The CWM 310 F universal combi-machine offers a large variety of applications hence ensures an attractive price-to-benefit ratio. The sliding table, featuring 2000 mm in length, the scoring unit which comes standard and the 3 spindle speeds are advantages that speak for themselves.

# CWM 310 F - 2000



Use the torsion-free square table to cut large panel conveniently.

Sawblade cover with integrated dust port positioned at riving knife. Comes complete with scoring unit.



**Best Price**

### Standard accessories:

- Cutter knives 310 x 30 x 3 mm
- Mortising unit
- Westcott drill chuck 0 - 16 mm
- Carbide sawblade 250 x 3,2 x 30 mm / 24T
- Scoring sawblade 80 x 3,2 x 20 mm / 8T
- Mitre fence with eccentric holder
- End stop
- Table extension
- Telescopic fence with stop
- Moulding fence
- Protective cover with dust extraction outlet and tube
- Push stick
- Tools



### Optional accessories:

	Art. no.	excl. VAT
Set of sawblades (3 pcs.) 250 mm, in aluminium case	17-1651	
Scoring sawblade 80 x 20 x 3 mm	17-1602	
Universal cutter head set 100 x 40 x 30 mm	16-2349	
Planer knives 310 x 30 x 3 mm, price per pc.	15-1005	
Mortising bit set 6 pcs. counterclockwise, 13 mm shaft	16-2003	
Planer knives adjustment HML	08-1500	

### Optional accessories:

	Art. no.	excl. VAT
Spiral cutter head with 30 pcs. TCT-blades	15-10810	
TCT-blades for spiral cutter (10 pcs.)	15-1076	
Dust collector DC 400 / 400 V	12-2060	
PU-tube diam. 100 mm (6 m)	12-1077	
Automatic start-up ALV 10 / 1 M	12-1150	
Lubricant 1 kg, paste	54-1000	

# Universal combined machines

# CU 310 F - 2000

- Powerful drive motors guarantee optimal results even at continuous operation
- Solid square table features roller for processing of heavy and large panel
- Machine body consists of a torsion-free, steel and grey cast-iron construction
- Extractable telescopic fence can be mounted at front or rear of square table
- Tilttable planer fence (90° to 45°) features generous surface
- Electronic speed display with LED when using spindle moulder
- Complete with mortising unit (16 mm capacity)
- Robust moulding fence with anodized fence rails
- Dynamically balanced moulder spindle for precise running
- Planer unit with precisely bedded 3-knife cutterblock

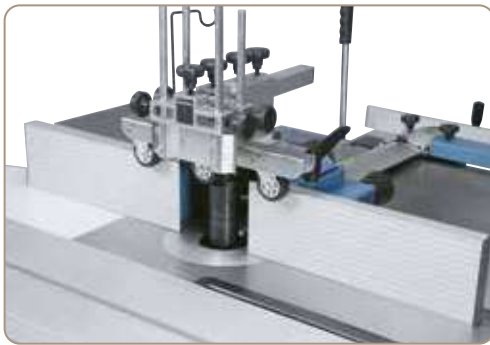

Solid protective cover for spindle moulder features fence rails with fine adjustment.

Square table with roll



Technical data	CU 310 F - 2000	CU 310 F - 2600	CU 310 F - 2000	CU 310 F - 2600
<b>Planer</b>				
Planing width	310 mm	310 mm		
Table length	1390 mm	1390 mm		
Table height	850 mm	850 mm		
Shaft rotation speed	4800 rpm	4800 rpm		
Cutter knives	3 pcs.	3 pcs.		
Planer shaft diameter	70 mm	70 mm		
Planer fence	1220 x 150 mm	1220 x 150 mm		
Fence tilttable	90° to 45°	90° to 45°		
Max. cutting depth	4 mm	4 mm		
Motor power output S <sub>1</sub> 100%	2,8 kW (3,8 HP)	2,8 kW (3,8 HP)		
Motor power input S <sub>6</sub> 40%	3,9 kW (5,3 HP)	3,9 kW (5,3 HP)		
<b>Thicknesser</b>				
Table length	540 mm	540 mm		
Working width	305 mm	305 mm		
Working thickness, min/max.	5 - 225 mm	5 - 225 mm		
Max. cutting depth	2 mm	2 mm		
Feed speed	6 m/min	6 m/min		
Dust extraction outlet	100 mm	100 mm		
<b>Mortising unit</b>				
Table size	500 x 200 mm	500 x 200 mm		
Westcott drill chuck	0 - 16 mm	0 - 16 mm		
Max. drill depth	155 mm	155 mm		
Drill width	285 mm	285 mm		
Height adjustment	140 mm	140 mm		
Dust extraction outlet	100 mm	100 mm		
<b>Circular saw</b>				
Table size			830 x 300 mm	830 x 300 mm
Table height			850 mm	850 mm
Table extension			505 x 300 mm	505 x 300 mm
Square table with roll			830 x 530 mm	830 x 530 mm
Sliding table			2000 x 270 mm	2600 x 270 mm
Cutting length			2000 mm	2600 mm
Max. sawblade diameter			315 x 30 mm	315 x 30 mm
Max. cutting height 90° / 45°			100 / 80 mm*	100 / 80 mm*
Cutting width on rip fence			630 mm	630 mm
Speed main sawblade			4500 rpm	4500 rpm
Speed scoring sawblade			8500 rpm	8500 rpm
Scoring sawblade			2-100 x 20 mm	2-100 x 20 mm
Dust extraction outlet			100 mm	100 mm
Motor power output S <sub>1</sub> 100%			2,8 kW (3,8 HP)	2,8 kW (3,8 HP)
Motor power input S <sub>6</sub> 40%			3,9 kW (5,3 HP)	3,9 kW (5,3 HP)
<b>Spindle moulder</b>				
Spindle diameter			30 mm	30 mm
Height adjustment			100 mm	100 mm
Table opening			80 / 100 / 140 / 190 mm	80 / 100 / 140 / 190 mm
Working length of spindle			100 mm	100 mm
Max. tool diameter				
- at profiling			180 mm	180 mm
- at tenoning			200 mm	200 mm
Spindle speed			1800 / 3000 / 6000 / 9000 rpm	
Motor power output S <sub>1</sub> 100%			2,8 kW (3,8 HP)	2,8 kW (3,8 HP)
Motor power input S <sub>6</sub> 40%			3,9 kW (5,3 HP)	3,9 kW (5,3 HP)
Voltage			400 V	400 V
Machine dimension (W x D x H)			2000 x 2990 x 1250 mm	2600 x 2990 x 1250 mm
Weight approx.			565 kg	590 kg
Art. no.			08-1293	08-1294

\* without scoring unit, sawblade 315 mm

The CU 310 F wood processing centre offers an enormous number of applications and best possible performance for professional users. The combination of planer, thicknesser, circular saw, spindle moulder and mortising unit all in one, gives a wide range of applications yet requires minimum space. This model is available with a choice of two table lengths: 2000 or 2600 mm.

# CU 310 F - 2600



Dynamically balanced 3-knife cutter-block eliminates vibrations to guarantee best results.



Sawblade protective cover, connected at riving knife, features integrated dust port. Comes complete with scoring unit.



Solid, grey cast-iron thickening table with central guiding in middle and clamp. Allows planing of workpieces up to 225 mm in height.

**Best Price**



**Serially with scoring unit**

**OPTIMUM**  
4 spindle speeds



**Standard accessories:**

- Cutter knives 310 x 25 x 3 mm
- Thicknesser table extension with roll
- Mortising unit
- Westcott drill chuck 0 - 16 mm
- Eccentric holder
- 4-size rotor group (16 / 20 / 22 / 25 mm)
- Carbide sawblade 254 x 3,0 x 30 mm / 40T
- Scoring sawblade 2-100 x 20 mm / 24T
- Height adjustment of milling spindle with magnifying glass
- Protective cover with dust extraction outlet and tube
- Mitre fence with eccentric holder
- End stop
- Table extension
- Telescopic fence with stop
- Square table with roll
- Moulding fence
- Sanding sleeve diam. 75 mm
- Spindle with left and right turning
- LED speed indication
- Push stick
- Tools



User-friendly switches and control elements, electronic speed display featuring LED.

Optional accessories:	Art. no.	excl. VAT
Planer knives HSS 310 x 25 x 3 mm, price per pc.	15-1003	
Scoring sawblade 2-100 x 20 mm	17-1604	
Universal cutter head set 100 x 40 x 30 mm	16-2349	
Dust collector DC 400 / 230 V	12-2055	

Optional accessories:	Art. no.	excl. VAT
Dust collector DC 400 / 400 V	12-2060	
Mortising bit set 6 pcs. counterclockwise, 13 mm shaft	16-2003	
Automatic start-up ALV 10 / 1 M	12-1150	
Carriage f. CU 310 F	56-1072	

# Universal combined machines

# CF 310 F - 2600

- Powerful drive motors guarantee optimal results even at continuous operation
- Square table with roller for convenient handling of large workpieces
- All aluminium parts (sliding table, fences,...) are anodized
- Moulding fence features aluminium fence rails on both sides incl. fine adjustment
- Large, grey cast-iron moulder unit, tilts from 0° to -45°
- Extractable telescopic fence with end stop and fine adjustment
- Milling spindle speed on digital display allows for quick and easy readout
- Solid planer fence with prism guide, tiltable from 90° to 45°
- Maintenance-free 4-knife cutterblock with planer knives in HSS – 18 % quality
- Solid moulding fence with dust extraction outlet 100 mm
- Dynamically balanced milling spindle ensures precise running

Right and left turning of spindle



The planer tables tilt into upright position to allow for optimal and safe working conditions even when thickening short workpieces.



**BERNARDO**  
SEMIPROFESSIONAL

Serially with scoring unit

## Technical data

## CF 310 F - 2600

### Planer

Planer width	310 mm
Table length	1600 mm
Table height	950 mm
Shaft rotation speed	4100 rpm
Cutter knives	4 pcs.
Planer shaft diameter	95 mm
Planer fence	1100 x 150 mm
Fence tiltable	90° to 45°
Max. cutting depth	5 mm
Motor power output S <sub>1</sub> 100%	2,2 kW (3,0 HP)
Motor power input S <sub>6</sub> 40%	3,0 kW (4,0 HP)

### Thickener

Table length	750 / 930* mm
Working width	305 mm
Working thickness, min/max.	5 - 230 mm
Max. cutting depth	5 mm
Feed speed	6 m/min
Dust extraction outlet	100 mm

### Mortising unit

Table size	450 x 190 mm
Westcott drill chuck	0 - 16 mm
Max. drill depth	125 mm
Drill width	175 mm
Height adjustment	115 mm

### Circular saw

Table size	1300 x 380 mm
Table height	950 mm
Table extension	310 x 350 mm
Square table with roll	880 x 580 mm
Sliding table	2600 x 270 mm
Cutting length	2600 mm
Max. sawblade diameter	315 x 30 mm
Max. cutting height 90° / 45°	100 / 80 mm
Cutting width on rip fence	630 mm
Speed main sawblade	4500 rpm
Speed scoring sawblade	8500 rpm
Scoring sawblade	90 x 20 mm
Dust extraction outlet	95 mm
Motor power output S <sub>1</sub> 100%	3,0 kW (4,0 HP)
Motor power input S <sub>6</sub> 40%	4,2 kW (5,7 HP)

### Spindle moulder

Spindle diameter	30 mm
Height adjustment	125 mm
Spindle tiltable	0° to -45°
Table opening	80 / 110 / 150 / 200 mm
Working length of spindle	110 mm
Max. tool diameter	180 mm
Spindle speed	1800 / 3000 / 6000 / 9000 rpm
Dust extraction outlet	100 mm
Motor power output S <sub>1</sub> 100%	2,8 kW (3,8 HP)
Motor power input S <sub>6</sub> 40%	3,9 kW (5,3 HP)
Voltage	400 V
Machine dimension (W x D x H)	2600 x 2700 x 1280 mm
Weight approx.	675 kg
Art. no.	08-1295



Complete with scoring unit for burr-free operation of panels.



The mortising unit is part of the standard accessories and ideal for drilling of oblong, dowel and angular holes.

\* with thickener table extension

The CF 310 F - 2000 wood processing centre combines several applications on limited space: planing, sawing, milling and drilling. The standard equipment includes a scoring unit, four spindle speeds, a tiltable moulding spindle and many more features that make this model unique and unbeatable.

# CF 310 F - 2600



The planing unit consists of a dynamically balanced 3-knife-cutterblock, in- and outfeed roller and massive anti-kick-back devices.



Aluminium fence rails come with fine adjustment and can easily and quickly be adjusted to each milling tool.



The torsion-free square table ensures smooth cutting of heavy and large panel. The extractable telescopic fence is equipped with an end stop with fine adjustment.

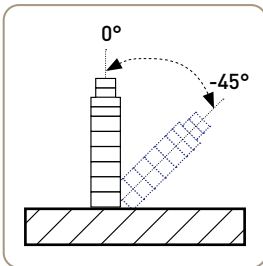

Square table with roll

**OPTIMUM**  
4 spindle speeds

**Standard accessories:**

- Cutter knives 310 x 30 x 3 mm
- Thicknesser table extension with roll
- Mortising unit
- Westcott drill chuck 0 - 16 mm
- Eccentric holder
- Carbide sawblade 315 x 3,0 x 30 mm / 40T
- Scoring sawblade 90 x 3,0 x 20 mm / 12T
- Protective cover with dust extraction outlet and tube
- Mitre fence with eccentric holder
- End stop
- Table extension
- Telescopic fence with stop
- Square table with roll
- Moulding fence
- Spindle with left and right turning
- Digital speed indication of moulding spindle
- Push handle
- 2 pcs. push stick
- Tools

**Best Price**



Electronic display of spindle speed settings.

Optional accessories:	Art. no.	excl. VAT
Planer knives HSS - 310 x 30 x 3 mm, per pc.	15-1005	
Spiral cutter head with 52 pcs. TCT-blades	15-10812	
TCT-blades for spiral cutter (10 pcs.)	15-1078	
Scoring sawblade 90 x 20 x 3 mm	17-1603	

Optional accessories:	Art. no.	excl. VAT
Universal cutter head set 100 x 40 x 30 mm	16-2349	
Dust collector DC 400 / 400 V	12-2060	
Mortising bit set 6-pcs. counterclockwise, 13 mm shaft	16-2003	
Automatic start-up ALV 10 / 1 M	12-1150	

# Universal combined machines

# CF 410 F - 2600

- Powerful drive motors guarantee optimal results even at continuous operation
- Solid planer fence with prism guide, tiltable from 90° to 45°
- Maintenance-free 4-knife cutterblock with planer knives in HSS – 18 % quality
- Square table with roller for convenient handling of large workpieces
- All aluminium parts (sliding table, fences,...) are anodized
- Moulding fence features aluminium fence rails on both sides incl. fine adjustment
- Large, grey cast-iron moulder unit, tilts from 0° to -45°
- Milling spindle speed on digital display allows for quick and easy readout
- Extractable telescopic fence with end stop and fine adjustment
- Solid moulding fence with dust extraction outlet 100 mm
- Dynamically balanced milling spindle ensures precise running

Right and left turning of spindle



Milling spindle tilts to the back, bringing several advantages, such as optimal use of the power feed, maximum safety and tidy milling results.



**BERNARDO**  
www.bernardo.at  
**SEMIPROFESSIONAL**

Solid construction

## Technical data CF 410 F - 2600

Planer		Circular saw	
Planer width	410 mm	Table size	1300 x 380 mm
Table length	1600 mm	Table height	950 mm
Table height	950 mm	Table extension	310 x 350 mm
Shaft rotation speed	4100 rpm	Square table with roll	880 x 580 mm
Cutter knives	4 Stk.	Sliding table	2600 x 270 mm
Planer shaft diameter	95 mm	Cutting length	2600 mm
Planer fence	1100 x 150 mm	Max. sawblade diameter	315 x 30 mm
Fence tiltable	90° to 45°	Max. cutting height 90° / 45°	100 / 80 mm
Max. cutting depth	5 mm	Cutting width on rip fence	730 mm
Motor power output S <sub>1</sub> 100%	2,2 kW (3,0 HP)	Speed main sawblade	4500 rpm
Motor power input S <sub>6</sub> 40%	3,0 kW (4,0 HP)	Speed scoring sawblade	8500 rpm
Thicknesser		Scoring sawblade	90 x 20 mm
Table length	750 / 930* mm	Dust extraction outlet	95 mm
Working width	405 mm	Motor power output S <sub>1</sub> 100%	3,0 kW (4,0 HP)
Working thickness, min/max.	5 - 230 mm	Motor power input S <sub>6</sub> 40%	4,2 kW (5,7 HP)
Max. cutting depth	5 mm	Spindle moulder	
Feed speed	6 m/min	Spindle diameter	30 mm
Dust extraction outlet	100 mm	Height adjustment	125 mm
Mortising unit		Spindle tiltable	0° to -45°
Table size	450 x 190 mm	Table opening	80 / 110 / 150 / 200 mm
Westcott drill chuck	0 - 16 mm	Working length of spindle	110 mm
Max. drill depth	125 mm	Max. tool diameter	180 mm
Drill width	175 mm	Spindle speed	1800 / 3000 / 6000 / 9000 rpm
Height adjustment	115 mm	Dust extraction outlet	100 mm
		Motor power output S <sub>1</sub> 100%	2,8 kW (3,8 HP)
		Motor power input S <sub>6</sub> 40%	3,9 kW (5,3 HP)
		Voltage	400 V
		Machine dimension (W x D x H)	2600 x 2800 x 1280 mm
		Weight approx.	765 kg
		Art. no.	08-1296

\* with thicknesser table extension



Grey cast iron thickening table features centre column and support for workpieces up to 230 mm.

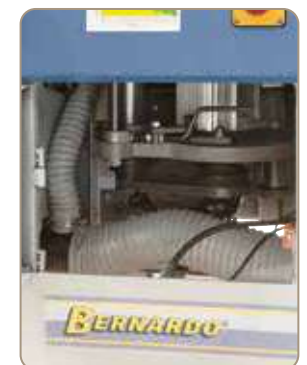

Large opening on machine front allows for easy belt change to adjust speed.

The CF 410 F - 2600 wood processing centre offers an enormous number of applications and best possible performance for professional users. The combination of planer, thicknesser, circular saw, spindle moulder and mortising unit all in one, gives a wide range of applications yet requires minimum space.

# CF 410 F - 2600



Tiltable parallel fence with micro-metric fine adjustment.



Sawblade protective cover, connected at riving knife, features integrated dust port. Comes complete with scoring unit.



The fences of moulding fence can easily and quickly be adjusted to different cutters. Part of the standard equipment is a protective device to avoid kickback of workpieces.

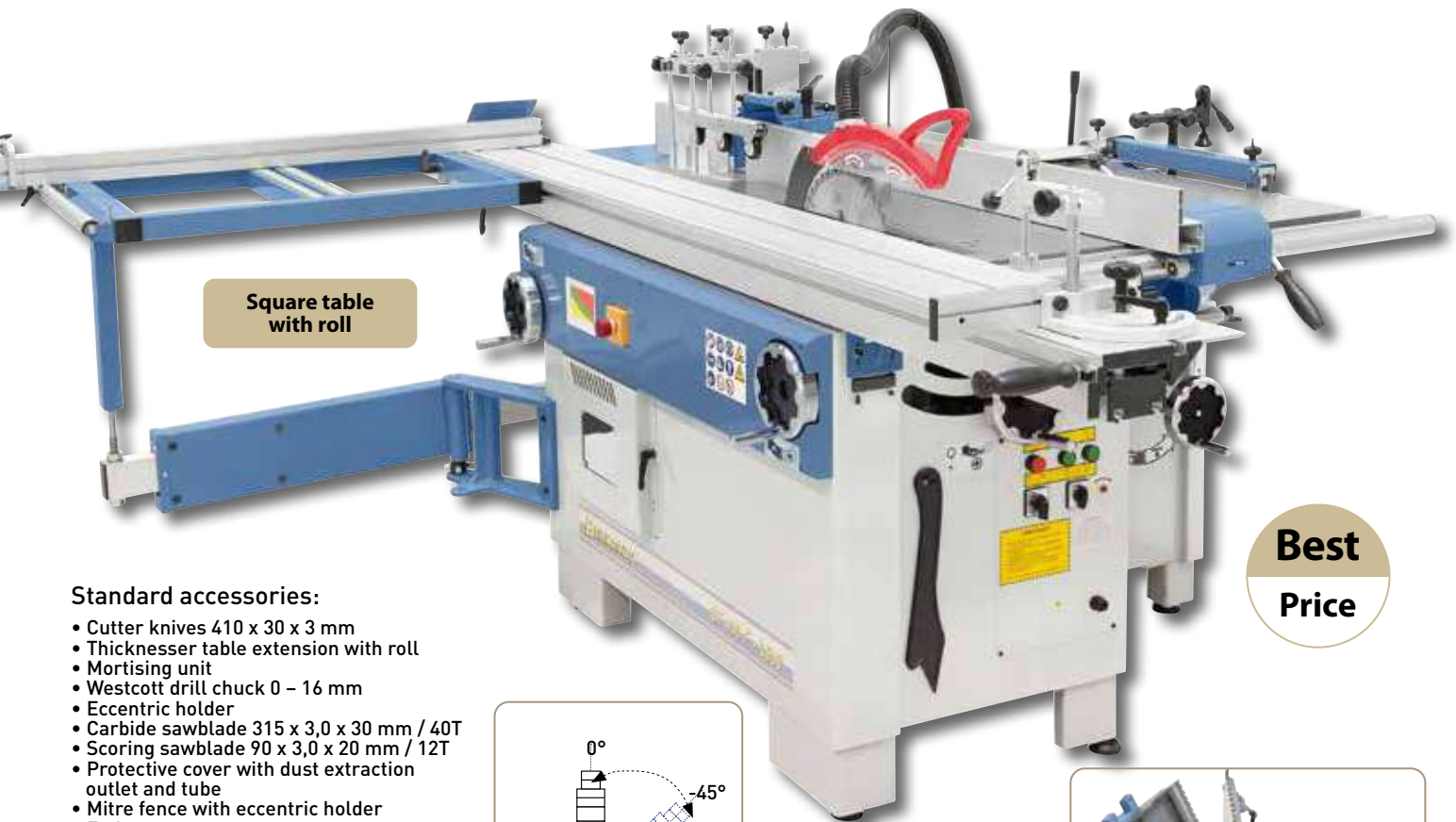

Square table with roll

**Best Price**

**Standard accessories:**

- Cutter knives 410 x 30 x 3 mm
- Thicknesser table extension with roll
- Mortising unit
- Westcott drill chuck 0 - 16 mm
- Eccentric holder
- Carbide sawblade 315 x 3,0 x 30 mm / 40T
- Scoring sawblade 90 x 3,0 x 20 mm / 12T
- Protective cover with dust extraction outlet and tube
- Mitre fence with eccentric holder
- End stop
- Table extension
- Telescopic fence with stop
- Square table with roll
- Moulding fence
- Spindle with left and right turning
- Digital speed indication of moulding spindle
- Push handle
- 2 pcs. push stick
- Tools

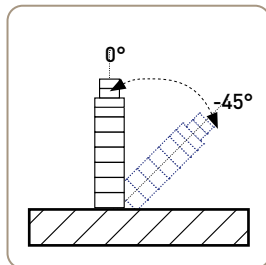

Integrated, tiltable dust hood - extraction outlet 100 mm.



**Optional accessories:**

- Planer knives HSS - 410 x 30 x 3 mm, per pc.
- Spiral cutter head with 72 pcs. TCT-blades
- TCT-blades for spiral cutter (10 pcs.)
- Scoring sawblade 90 x 20 x 3 mm

Art. no.	excl. VAT
15-1016	
15-10811	
15-1078	
17-1603	

**Optional accessories:**

- Universal cutter head set 100 x 40 x 30 mm
- Dust collector DC 400 / 400 V
- Mortising bit set 6-pcs. counterclockwise, 13 mm shaft
- Automatic start-up ALV 10 / 1 M

Art. no.	excl. VAT
16-2349	
12-2060	
16-2003	
12-1150	

Your dealer

**ORPI SL**

C/ Juan de la Cierva, 23  
50014 Zaragoza

Tlfn: 976 471 440

[www.orpi-sl.com](http://www.orpi-sl.com)    [orpi@orpi-sl.com](mailto:orpi@orpi-sl.com)

***BERNARDO***<sup>®</sup>  
[www.bernardo.at](http://www.bernardo.at)

**PWA Handelsges.m.b.H.**

4020 Linz | Nebingerstraße 7a | Austria  
phone: +43.732.66 40 15 | fax: +43.732.66 40 15-9  
e-mail: [bernardo@pwa.at](mailto:bernardo@pwa.at) | [www.bernardo.at](http://www.bernardo.at)

**Imprint:**

All rights reserved – reproduction of images or texts or parts of these is strictly prohibited unless prior arrangements are made. Subject to technical and optical amendments. Product specifications subject to change without notice. Not responsible for printing errors or mistakes. Machines are partly displayed with optional extras. Prices subject to change. Prices in Euros, ex works (Linz, Austria), excl. any taxes. Edition 01/2024.