

BERNARDO®

www.bernardo.at

ORPI

01 | 2024

SAWING MACHINES



SS 405 Vario
SS 460
ZKG 305 D
Uzt 400
TK 200 RN
TK 250 RN
TK 200 RSN
TK 250 RSN

TK 200 PRO
TK 250 PRO
PKS 250 P
TK 250 F
FKS 1300 H
FKS 1600 H
STS 1300 eco
STS 1600 eco
FKS 1250 N
FKS 1600 N

STS 1360
STS 1600
TK 315 P - 1600
TK 315 P - 1800
TK 315 P - 2000
Basic 2000 Pro
Basic 2600 Pro
Basic 2800 Pro
Basic 3200 Pro
FKS 1600 Pro

FKS 2000 Pro
FKS 2600 Pro
FKS 2800 Pro
FKS 3200 Pro
Procut 3200 P
Classic 1300 C
Classic 1600 C
Classic 2500 C
Classic 3200 C
Topcut 3200 ER

Scroll saw

SS 405 Vario

The SS 405 Vario scroll saw is suitable for cutting various materials such as wood, plastics, non-ferrous metals, styrofoam and alike. The flexible shaft and several grinding pins increase the number of applications significantly. This model is primarily used in model-making.

- Ideal for inner and outer cutting and cutting of the smallest radius
- Comes with flexible shaft and several grinding pins for additional applications
- Suitable for commercial scroll sawblades with or without pin
- Stepless stroke rate regulation ensures ideal adjustment to each specific material
- Includes blowing device for optimal view of cutting line
- Quick clamp system allows for easy sawblade change
- Robust cast iron construction ensures smooth run free from vibrations
- Tiltable work table for mitre cuts from 0° to +45°



The standard blow-out device removes the saw dust, thus providing an optimal view of the cutting line.



Tiltable working table from 0° to 45° for mitre cuts.



Stepless adjustable number of strokes using a potentiometer.

Standard accessories:

- Sawblades (2 pcs.)
- Sawblade cover
- LED working light
- Workpiece downholder
- Blowing device
- Tools
- Flexible shaft with different pins, grinding / polishing and cutoff wheels

Technical data

SS 405 Vario

Throat	405 mm
Working height	52 mm
Sawblade length	130 mm
Number of strokes, stepless	550 - 1600 / min.
Table size	Ø 250 x 410 mm
Table tilting range	0° to 45°
Dust extraction outlet	35 mm
Motor power	90 W
Voltage	230 V
Machine dimension (W x D x H)	330 x 630 x 380 mm
Weight approx.	10 kg
Art. no.	14-2254

BERNARDO®

HOBBY

**2 in 1 - scroll saw
with flexible shaft**



Flexible shaft with various pins, grinding, polishing and cutoff wheels comes standard.



Optional accessories:

Fret sawblade 130 mm, fine, for wood, plastics, plaster (12 pcs.)	Art. no.	excl. VAT
Fret sawblade 130 mm, middle, for wood, plastics, plaster (12 pcs.)	11-2190	
Fret sawblade 130 mm, fine, for metal (12 pcs.)	11-2191	
Adapter A100/70 - A65/45 - A40/40 - A35/35	11-2193	
	12-1034	

Scroll saw

SS 460

The SS 460 scroll saw is suitable for cutting various materials such as wood, plastics, non-ferrous metals, styrofoam and alike. The flexible shaft and several grinding pins increase the number of applications significantly. This model is primarily used in model-making.

- Includes blowing device for optimal view of cutting line
- Quick clamp system allows for easy sawblade change
- Stepless stroke rate regulation ensures ideal adjustment to each specific material
- Robust cast iron construction ensures smooth run free from vibrations
- Comes with flexible shaft and several grinding pins for additional applications
- Suitable for commercial scroll sawblades with or without pin
- Tilttable work table for mitre cuts from -10° to $+45^{\circ}$
- Ideal for inner and outer cutting and cutting of the smallest radius

**2 in 1 - scroll saw
with flexible shaft**



Height adjustable, transparent sawblade cover for optimal view of workpiece.



Flexible shaft featuring several grinding pins included in standard equipment.



Stepless stroke adjustment.



Tilttable work table from -10° to $+45^{\circ}$.



Examples of use:
Outer / Inner cut



BERNARDO
www.bernardo.it
HOBBY

Technical data

SS 460

Throat	460 mm
Working height	52 mm
Sawblade length	130 mm
Number of strokes, stepless	550 - 1650 /min.
Table size	\varnothing 250 x 480 mm
Table tilting range	-10° to $+45^{\circ}$
Dust extraction outlet	35 mm
Motor power	120 W
Voltage	230 V
Machine dimension (W x D x H)	400 x 690 x 370 mm
Weight approx.	20 kg
Art. no.	14-2255

Standard accessories:

- Sawblades (3 pcs.)
- Sawblade cover
- Working light
- Workpiece downholder
- Blowing device
- Tools
- Flexible shaft with different pins, grinding / polishing and cutoff wheels

Optional accessories:

Fret sawblade 130 mm, fine, for wood, plastics, plaster (12 pcs.)	Art. no.	excl. VAT
Fret sawblade 130 mm, middle, for wood, plastics, plaster (12 pcs.)	11-2190	
Fret sawblade 130 mm, fine, for metal (12 pcs.)	11-2191	
Adapter A100/70 - A65/45 - A40/40 - A35/35	11-2193	
	12-1034	

Mitre saw

ZKG 305 S

- Ideal for cutting of wood, plastics and non-ferrous metals
- Precise double column guide for smooth and even travel
- Powerful motor for best results even at long operations
- Complete with carbide sawblade (60T) for high quality cutting and burr-free results
- Table extensions on both sides for optimal workpiece support
- Equipped with integrated cutting depth stop for groove cutting
- Sawblade gets covered automatically when lifting the saw unit
- Suitable for cross, bevel and mitre cutting
- Dust port directly at saw unit comes standard
- Locking device allows for quick and easy sawblade change
- Rotary disc with rests at 0° / 15° / 22.5° / 30° / 45°
- Low weight makes it easy to transport
- Easy to read scale for bevel and mitre angles plus cutting width

**Best
Price**



Solidly constructed rotary disc features integrated scale which tilts 45° to the left and 45° to the right when mitre cutting.



The linear laser device shows the exact position of the sawblade.



Secure mounting of workpiece with height adjustable downholder.



Column guiding can be locked to ensure safe transport.



Optional extra: Universal base KSU 1100, ideal for supporting long workpieces

Technical data

ZKG 305 S

Sawblade diameter x bore	305 x 30 mm
No load speed	4800 rpm
Cutting capacity	
Straight cuts at 90° / 90°	305 x 105 mm
Mitre cuts at 45° right / left*	210 x 105 mm
Grade cuts at 45° left**	305 x 50 mm
Double mitre cuts at 45° left	210 x 50 mm
Motor power	1,8 kW (2,4 HP)
Voltage	230 V
Machine dimension (W x D x H)	910 x 1080 x 670 mm
Weight approx.	20 kg
Art. no.	09-10020

* rotary disc

** saw unit

Standard accessories:

- Carbide sawblade 305 x 2,8 x 30 mm / 60T
- Table extension
- Linear laser device
- Waste bag
- Downholder

The ZKG 305 S is a suitable model for cross, bevel and mitre cutting. The particularly large cutting width of 305 mm, the linear laser device for top accuracy and the high fence for safe mounting of the workpiece make this machine ideal for experienced amateurs.

ZKG 305 S



Powerful drive motor (1800 W) with electronic motor brake.



Sawblade gets covered automatically when lifting the sawblade



The precise double column guide allows for smooth and even travel of the saw unit.

BERNARDO
www.bernardo.at
SEMIPROFESSIONAL



Saw head tilts 45° to the left.

Optional accessories:

Carbide sawblade WZ, 305 x 3,0 x 25,4 mm, 80T
Digital angle finder

Art. no.	excl. VAT
17-1121	
31-1044	

Optional accessories:

Universal base KSU 1100
Universal base KSU 1560

Art. no.	excl. VAT
07-1537	
07-1538	

Double mitre saws

ZKG 305 D

- Suitable for cutting wood, coated panels, plastics and non-ferrous metals
- Complete with linear laser device to show exact position of sawblade
- Precise double column guide for smooth and even travel
- Powerful motor for top results even at long operations
- Table extensions on both sides ensures optimal workpiece support
- Includes integrated cutting depth stop for groove cutting
- Sawblade gets covered automatically when lifting the sawblade
- Usable for straight-, grade-, mitre and double mitre cuts
- Equipped with dust port directly at saw unit
- Easy and quick sawblade change with locking device
- To guarantee for safe transport column can be locked into position
- Rotary disc with rests at 0° / 15° / 22.5° / 31.6° and 45°
- Low weight allows for easy transport
- Easy to read scales for mitre and bevel angles and cutting width



Powerful motor with belt drive.



Comes complete with height adjustable downholder to secure the workpiece.



Table extensions - extractable on both sides - with workpiece support and tiltable fences for series cuts.



Rotary disc swivels 45° to both sides and features rests at 0° / 15° / 22.5° / 31.6° and 45°.



Includes carry handle, ideal for transport between sites.

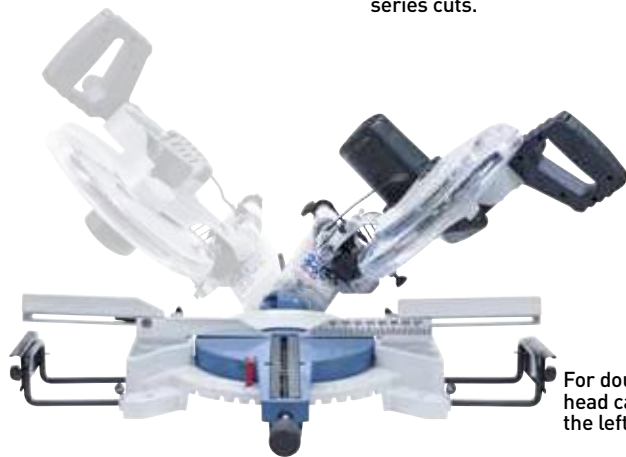

BENEFIT

**Double mitre
Double grade**

For double mitre cuts the saw head can be swivelled 45° to the left and to the right.

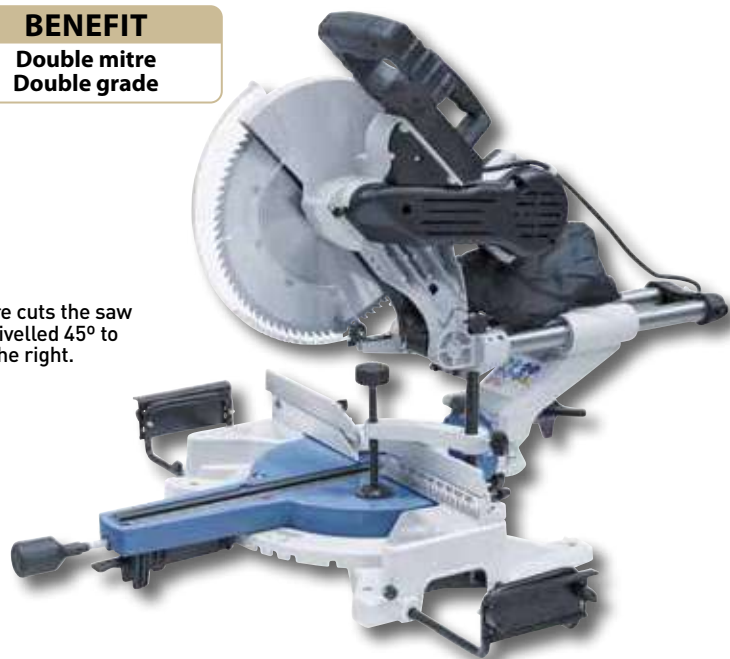

Standard accessories:

- Carbide sawblade 305 x 3,0 x 25,4 mm / 80T
- Table extension
- Extractable stop fence
- Linear laser device
- Waste bag
- Downholder

Technical data

ZKG 305 D

Sawblade diameter x bore	305 x 25,4 mm
No load speed	4800 rpm
Cutting capacity	
Straight cuts at 90° / 90°	340 x 95 mm
Mitre cuts at 45° right / left	240 x 95 mm
Grade cuts at 45° left*	340 x 55 mm
Grade cuts at 45° right*	340 x 55 mm
Double mitre cuts at 45° left	240 x 55 mm
Double mitre cuts at 45° right	240 x 55 mm
Motor power	1,6 kW (2,2 HP)
Voltage	230 V
Machine dimension (W x D x H)	860 x 900 x 680 mm
Weight approx.	28 kg
Art. no.	09-1005

* saw unit

The ZKG 305 D is the perfect solution for the processing of wood, plastic profiles, coated panels and non-ferrous metals. The large variety of standard equipment, such as the double grade and double mitre feature, the high workpiece fence and the laser device, make these machine universal and flexible for interior works.

ZKG 305 D

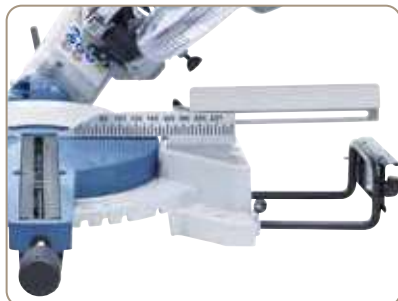

The extractable fences allow optimal guiding of longer workpieces.



Double column guide of saw unit offers extremely high rigidity.



Optional accessories:

Carbide sawblade WZ, 305 x 3,0 x 25,4 mm, 80T
Digital angle finder

Art. no. excl. VAT
17-1121
31-1044

Optional accessories:

Universal base KSU 1100
Universal base KSU 1560

Art. no. excl. VAT
07-1537
07-1538

Heavy duty circular saw

UZZ 400

- Simultaneously adjustable rotary disc (up to 90°) and sawblade (up to 45°)
- Ideal device for experienced craftsmen for building for instance carports, garden and dog huts, canopies etc.
- Lever allows for cross cutting, saw unit travels from bottom to top
- Solid and easily adjustable saw unit for cutting heights up to 120 mm
- Add the optionally available infeed and outfeed roller tables to achieve the maximum capacity of this model
- User-friendly saw unit convenient for various cutting operations
- Maintain a clean work environment by connecting a dust collector to the sawblade cover or the saw unit



Sliding table with fence



The protective cover follows the sawblade movement.



Electronic box with power socket



Standard version

BERNARDO
www.bernardo.at
SEMIPROFESSIONAL

Standard accessories:

- Carbide sawblade 400 x 4,0 x 30 mm, 28T
- Protective cover with dust extraction outlet
- Roller table
- Carriage
- Tool storage
- Push stick

Technical data	UZZ 400
Table size	945 x 715 mm
Max. sawblade diameter	400 x 30 mm
Max. cutting height 90° / 45°	120 / 90 mm
Table height	845 mm
Movable infeed roller table (optional)	1000 x 550 mm
Movable outfeed roller table (optional)	1000 x 550 mm
Speed main sawblade	2800 rpm
Dust extraction outlet top / bottom	100 / 100 mm
Motor power output S ₁ 100%	2,8 kW (3,8 HP)
Motor power input S ₆ 40%	3,9 kW (5,3 HP)
Voltage	400 V
Machine dimension (W x D x H)	1350 x 1400 x 1200 mm
Machine dimension with roller table*	3500 x 1400 x 1200 mm
Weight approx.	210 kg
Art. no	09-1022

* optional



Optional accessories:

- Carbide sawblade 400 x 4,0 x 30 mm, 96T
- Infeed roller table 1000 mm
- Outfeed roller table 1000 mm

Art. no. excl. VAT
 18-1003
 09-1023
 09-1024

The UZT 400 heavy duty circular saw is suitable for cross cuts and longitudinal cuts. The rotary disc and the tiltable sawblade allow a large variety of applications, such as jack rafter cutting, ripping, mitre and straight cross cutting. It allows the production of valley- and hip rafter as well as the cutting of gutter boards and wedge planks.

UZT 400



Straight cross cut 90°



Jack rafter cut 45°



Mitre cross cut 90° + 45°



Sawing with sliding table

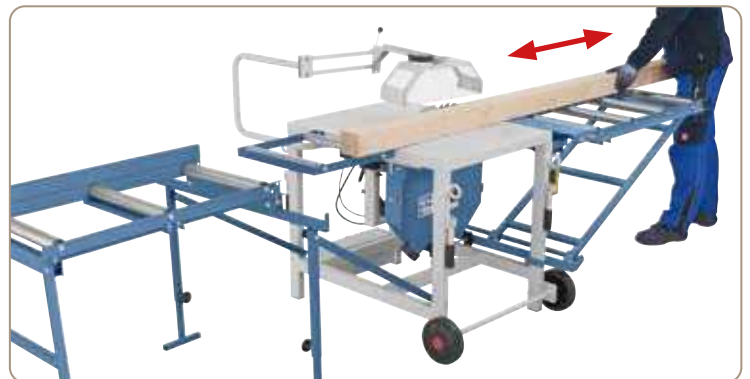

Parallel separation cut

Universally usable



Picture shows outfeed and infeed roller table (optional extra).



Includes carriage for easy transport

Table saws

TK 200 RN TK 250 RN

The ideal table saws featuring a large number of applications for amateurs, combining high cutting capacity and top precision on limited space. Comes complete with roller table to increase user comfort even more.

- Solid and easily adjustable saw unit, tilts from 90° to 45°
- Solid grey cast-iron table with T-slots for cutting with the mitre fence left and right of sawblade
- Complete with roller table featuring aluminium fence
- Table extension for better support of larger panels comes standard
- ON-OFF switch in accordance with IP 54 features undervoltage release and separate emergency stop
- Mitre fence for angle cuts up to 45° is part of standard equipment
- Ergonomically arranged handwheels allow for convenient setting of cutting height and the cutting angle
- Left tilting sawblade ensures better cutting guide on longitudinal fence



**Best
Price**



Grey cast-iron roller table, manufactured with precision and polished

BERNARDO
www.bernardo.at
HOBBY



Left tilting sawblade improves handling at bevel cuts.



Table extension for cutting width up to 720 mm comes standard.

Sawblade can be tilted to the left

Technical data	TK 200 RN	TK 250 RN
Table size	530 x 400	630 x 430 mm
Roller table	400 x 250 mm	400 x 250 mm
Travel of roller table	720 mm	920 mm
Max. sawblade diameter	200 x 30 mm	250 x 30 mm
Max. cutting height 90° / 45°	55 / 42 mm	80 / 60 mm
Cutting width on rip fence	730 mm	700 mm
Table height	890 mm	890 mm
Table extension	530 x 600 mm	635 x 600 mm
Speed main sawblade	4750 rpm	4750 rpm
Dust extraction outlet	100 mm	100 mm
Motor power output S ₁ 100%	1,1 kW (1,5 HP)	1,5 kW (2,0 HP)
Motor power input S ₆ 40%	1,5 kW (2,0 HP)	2,1 kW (2,85 HP)
Voltage	230 V	230 V
Machine dimension (W x D x H)	1520 x 1000 x 1050 mm	1500 x 1200 x 1100 mm
Weight approx.	72 kg	86 kg
Art. no.	09-1041	09-1042

Standard accessories:

- Carbide sawblade 200 x 2,2 x 30 mm / 32T (TK 200 RN)
- Carbide sawblade 250 x 2,8 x 30 mm / 40T (TK 250 RN)
- Protective cover with dust extraction outlet
- Double sided mitre fence
- Table extension
- Aluminium fence with stop
- Roller table
- Braking motor (TK 250 RN)
- Stand
- Tools

Table saws

The TK 200 RSN and TK 250 RSN mainly differs from the RN-models with regard to the closed machine base which increases the rigidity and stability of the machines significantly.

TK 200 RSN TK 250 RSN

BERNARDO®
www.bernardo.at

HOBBY

Sawblade can be tilted to the left



Protective sawblade cover with integrated dust port connected on riving knife.



TK 250 RN / TK 250 RSN

**TK 250 RS / RN:
Cutting height 80 mm**

Standard accessories:

- Carbide sawblade 200 x 2,2 x 30 mm / 32T (TK 200 RSN)
- Carbide sawblade 250 x 2,8 x 30 mm / 40T (TK 250 RSN)
- Protective cover with dust extraction outlet
- Double sided mitre fence
- Table extension
- Aluminium fence with stop
- Roller table
- Braking motor (TK 250 RSN)
- Closed machine base
- Tools

Optional accessories:

	Art. no.	excl. VAT
Carbide sawblade 205 x 2,2 x 30 mm / 32T	17-1117	
Carbide sawblade 250 x 2,8 x 30 mm / 40T	17-1122	
Dust collector DC 200 E / 230 V with tube (2,0 m)	12-2039	
Automatic start-up ALV 2 / M 230 - 230 V	12-1152	
Universal mobile base MB 230	56-10700	
Grounding set ES 1	12-1140	



Ergonomically arranged handwheels on machine body allow for adjustment of saw unit.



Aluminium fence with end stop and downholder is part of standard equipment.

Technical data	TK 200 RSN	TK 250 RSN
Table size	530 x 400 mm	630 x 430 mm
Roller table	400 x 250 mm	400 x 250 mm
Travel of roller table	720 mm	920 mm
Max. sawblade diameter	200 x 30 mm	250 x 30 mm
Max. cutting height 90° / 45°	55 / 42 mm	80 / 60 mm
Cutting width on rip fence	730 mm	700 mm
Table height	900 mm	900 mm
Table extension	530 x 600 mm	635 x 600 mm
Speed main sawblade	4700 rpm	4750 rpm
Dust extraction outlet	100 mm	100 mm
Motor power output S ₁ 100%	1,1 kW (1,5 HP)	1,5 kW (2,0 HP)
Motor power input S _e 40%	1,5 kW (2,0 HP)	2,1 kW (2,85 HP)
Voltage	230 V	230 V
Machine dimension (W x D x H)	1520 x 1010 x 1050 mm	1500 x 1200 x 1100 mm
Weight approx.	84 kg	101 kg
Art. no.	09-1043	09-1044

Table saws

TK 200 PRO TK 250 PRO

- Mitre fence either usable on right or left of sawblade, suitable for angle cuts up to 45°
- Powerful drive motor ensures constant cutting speed, even at 80 mm cutting height
- ON-OFF switch in accordance with IP 54 features undervoltage release and separate emergency stop
- Cost-effective base model, extensive range of accessories for expanded use
- Left tilting sawblade ensures better cutting guide on longitudinal fence
- Casting machine table features high accuracy and two T-slots
- Standard accessories include mitre fence and sawblade
- Including rip fence for cutting of narrow and thin workpieces
- Handwheel allows for tilting of saw unit up to 45°



ON-OFF switch in accordance with IP 54 features undervoltage release and separate emergency stop.



Ensure optimal work conditions by connecting a dust collector to the 100 mm dust port.

BERNARDO®
www.bernardo.at
HOBBY

Sawblade can be tilted to the left

Solid construction

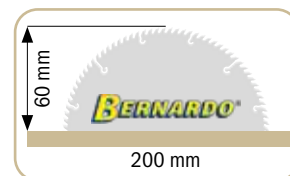

TK 200 PRO



Picture TK 200 PRO with basic execution and closed stand.

Standard accessories:

- Carbide sawblade 200 x 2,2 x 30 mm / 32T (TK 200 PRO)
- Carbide sawblade 250 x 2,8 x 30 mm / 40T (TK 250 PRO)
- Protective cover with dust extraction outlet
- Double sided mitre fence
- Rip fence with loupe
- Separate emergency stop
- Braking motor (TK 250 PRO)
- Tools

Optional accessories TK 200 / 250 PRO:

Optional accessories TK 200 / 250 PRO:	Art. no.	excl. VAT
Carbide sawblade 205 x 2,2 x 30 mm / 32T	17-1117	
Carbide sawblade 250 x 2,8 x 30 mm / 40T	17-1122	
Dust collector DC 200 E / 230 V with tube (2,0 m)	12-2039	
Automatic start-up ALV 2 / M 230 - 230 V	12-1152	
Universal mobile base MB 230	56-10700	
Grounding set ES 1	12-1140	

Technical data

TK 200 PRO

Table size	600 x 400 mm
Roller table*	400 x 250 mm
Travel of roller table*	720 mm
Max. sawblade diameter	200 x 30 mm
Max. cutting height 90° / 45°	60 / 45 mm
Cutting width on rip fence	200 mm**
Table height	350 mm
Table extension*	560 x 600 mm
Speed main sawblade	4750 rpm
Dust extraction outlet	100 mm
Motor power output S ₁ 100%	1,1 kW (1,5 HP)
Motor power input S ₆ 40%	1,5 kW (2,0 HP)
Voltage	230 V
Machine dimension (W x D x H)	770 x 540 x 520 mm
Weight approx.	55 kg
Art. no.	09-1048

* optional

** 725 mm with optional table extension

The table saws of the PRO-series are cost-effective base models for quick machining of small workpieces. Through the extensive range of accessories (roller table, extension table, open and closed stand, these machines allowing individual adaption to suits the needs of the user and can be expanded at any time.

TK 200 PRO TK 250 PRO



The optional extension table ensure a cutting width up to 725 mm.



Left tilting sawblade enables workpiece to be guided more easily during cut.



The optionally available roller table with aluminium fence and eccentric holder widens the application range additionally.

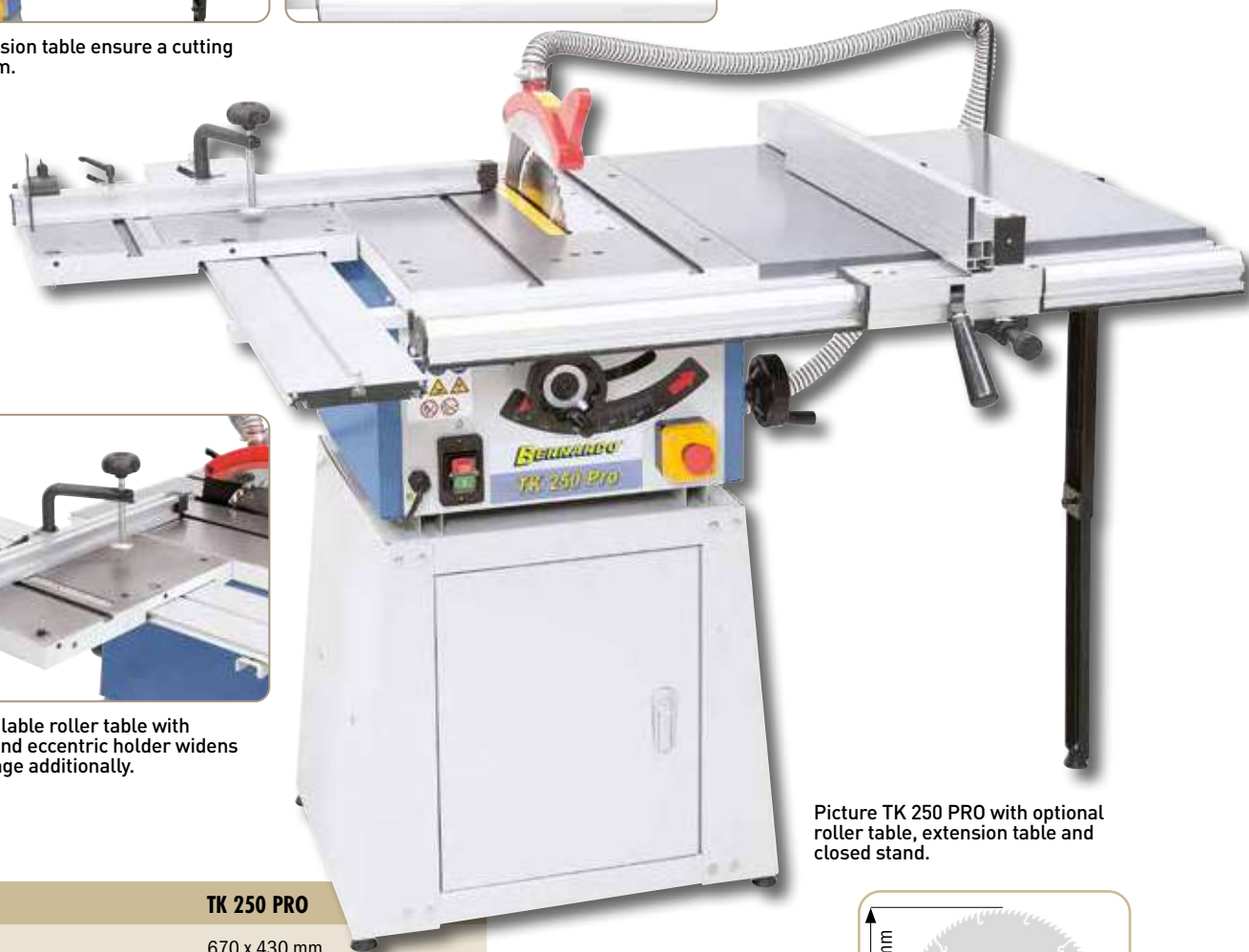

Picture TK 250 PRO with optional roller table, extension table and closed stand.

Technical data

TK 250 PRO

Table size	670 x 430 mm
Roller table*	400 x 250 mm
Travel of roller table*	920 mm
Max. sawblade diameter	250 x 30 mm
Max. cutting height 90° / 45°	80 / 60 mm
Cutting width on rip fence	200 mm**
Table height	355 mm
Table extension*	600 x 670 mm
Speed main sawblade	4750 rpm
Dust extraction outlet	100 mm
Motor power output S ₁ 100%	1,5 kW (2,0 HP)
Motor power input S ₆ 40%	2,1 kW (2,8 HP)
Voltage	230 V
Machine dimension (W x D x H)	850 x 600 x 550 mm
Weight approx.	67 kg
Art. no.	09-1053

* optional

** 725 mm with optional table extension



TK 250 PRO

Optional accessories TK 200 / 250 PRO:

	Art. no.	excl. VAT
Roller table for TK 200 PRO	09-1049	
Extension table for TK 200 PRO	09-1051	
Stand open for TK 200 PRO	09-1052	
Stand closed for TK 200 PRO / TK 250 PRO	09-1054	
Roller table for TK 250 PRO	09-1056	
Extension table for TK 250 PRO	09-1057	
Stand open for TK 250 PRO	09-1058	

Precision saw

PKS 250 P

- Solid grey cast-iron table features T-slot for the mitre fence
- Tiltable sawblade from 90° to 45° by handwheel
- Rip fence can be turned 90° for cutting of narrow and thin workpieces
- Complete with table extension for convenient cutting of large panels
- Smooth, precise sliding table with prism-shaped guide
- Aluminium rip fence with fine adjustment and precise 30 mm round rod guide
- Solid saw unit guarantees accurate work, free from vibrations
- Powerful drive motor ensures constant cutting speed, even at cutting height of 80 mm
- Large, grey cast-iron machine table, built with top accuracy and polished surfaces
- Torsion-free, steel and grey cast-iron machine body

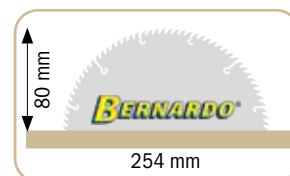

Sawblade can be tilted from 90° to 45° for precise angle cuts.



30 mm round rod allows for precise guiding of aluminium parallel fence.



T-slot in sliding table allow mounting of mitre fence or end stop.



Ergonomic mounted handwheels allow for height adjustment and tilting of the saw unit.



Technical data

PKS 250 P

Table size	670 x 310 mm
Sliding table	1300 x 250 mm
Cutting length	1020 mm
Max. sawblade diameter	254 x 30 mm
Max. cutting height 90° / 45°	80 / 65 mm
Cutting width on rip fence	670 mm
Table height	870 mm
Table extension	670 x 400 mm
Speed main sawblade	4750 rpm
Dust extraction outlet	100 mm
Motor power output S ₁ 100%	2,2 kW (3,0 HP)
Motor power input S ₆ 40%	3,0 kW (4,0 HP)
Voltage	230 V or 400 V
Machine dimension (W x D x H)	1300 x 1180 x 1100 mm
Weight approx.	108 kg
Art. no.	09-1062 (230 V) 09-1063 (400 V)

Standard accessories:

- Carbide sawblade 254 x 3,0 x 30 mm / 24T
- Protective cover with dust extraction outlet
- Mitre fence with stop bar 265 mm
- Mitre fence
- End stop
- Sliding table 1300 mm
- Table extension
- Push stick
- Machine base
- Tools

**Best
Price**

The PKS 250 P precision saw features several technical innovations, such as a sliding table 1300 mm, longitudinal fence with fine adjustment, sawblade tilting on the front side and many more, which are rather unusual for a machine of this size. Most commonly this model is used among amateurs, craftsmen and in small businesses.

PKS 250 P



Sawblade cover - with integrated dust port - connected at riving knife.



Parallel fence features micrometric fine adjustment, suitable for cutting width up to 670 mm.

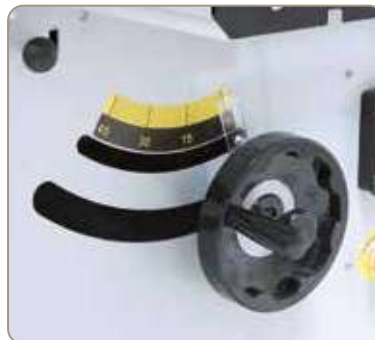

Sawblade angle can easily be read out on scale.



Incl. sliding table
1300 mm



Solid
construction

VOLTAGE

Alternatively in
230 V or 400 V

Powder coated

Optional accessories:

Set of sawblades (3 pcs.) 250 mm, in aluminium case
Dust collector DC 230 E / 230 V with tube (2,5 m)
Dust collector DC 300 / 400 V

Art. no.	excl. VAT
17-1651	
12-2043	
12-2045	

Optional accessories:

PU-tube diam 100 mm (6 m)
Automatic start-up ALV 10 / 1 M
Universal mobile base MB 230

Art. no.	excl. VAT
12-1077	
12-1150	
56-10700	

- Complete with user-friendly sliding table with a surface of 410 x 710 mm
- Extractable telescopic fence (up to 2000 mm) mountable at front or rear of square table, steplessly tiltable from 90° to 45°
- Mitre fence either usable on right or left of sawblade, suitable for angle cuts up to 45°
- Ergonomically arranged handwheels allow for setting of saw unit
- Solid grey cast-iron table with T-slots on right and left of sawblade
- Includes table extension on the right for better support of large boards
- Solid and easily adjustable saw unit, tiltable from 90° to 45°
- Square table ensures convenient machining of large boards



Includes easily adjustable rip fence with quick clamping system and table extension for cutting width up to 730 mm.



Radial-pull cutting for easy processing of long workpieces.

Top
Seller



Handwheel features gear rim guide to allow for easy and smooth sawblade tilt.

Including radial-pull
sawing device



Technical data

TK 250 F

Table size	800 x 520 mm
Sliding table	410 x 710 mm
Cutting length	1230 mm
Max. sawblade diameter	254 x 30 mm
Max. cutting height 90° / 45°	82 / 54 mm
Travel of sawblade	225 mm
Cutting width on rip fence	730 mm
Table height	900 mm
Table extension	800 x 320 mm
Square table	600 x 410 mm
Speed main sawblade	4000 rpm
Dust extraction outlet	100 mm
Motor power output S ₁ 100%	1,5 kW (2,0 HP)
Motor power input S ₆ 40%	2,1 kW (2,85 HP)
Voltage	230 V
Machine dimension (W x D x H)	2020 x 2300 x 1200 mm
Weight approx.	175 kg
Art. no.	09-1070

Standard accessories:

- Carbide sawblade 254 x 3,0 x 30 mm / 36T
- Protective cover with dust extraction outlet
- Connector tube with Y-piece
- Mitre fence with eccentric holder
- Table extension right
- Extractable telescopic fence
- Square table
- Radial-pull sawing device
- Push stick
- Tools

The smooth running sliding table features an additional tilting support arm to allow for processing of large panels.

The TK 250 F powerful table saw comes complete with sliding table including a square table and a radial-pull sawing device. The extensive range of standard equipment and the large number of applications make this model an attractive option for the professional user in terms of price and benefit.

TK 250 F



The steplessly tiltable telescopic fence (2 x 45°) can be mounted at the front or rear of the square table.

BERNARDO
www.bernardo.at
HOBBY

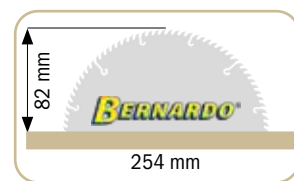

Optional accessories:	Art. no.	excl. VAT
Set of sawblades (3 pcs.) 250 mm, in aluminium case	17-1651	
Dust collector DC 230 E / 230 V with tube 2,5 m	12-2043	
Dust collector DC 300 / 400 V	12-2045	
PU-tube diam 100 mm (6 m)	12-1077	

Optional accessories:	Art. no.	excl. VAT
Automatic start-up ALV 10 / 1 M	12-1150	
Automatic start-up ALV 2 / M 230 - 230 V	12-1152	
Digital angle finder	31-1044	
Universal mobile base MB 230	56-10700	

Sliding table saws

FKS 1300 H

FKS 1600 H

- Complete with aluminium sliding table with a surface of 1300 x 240 mm or 1600 x 240 mm
- Ensure optimal work conditions by connecting a dust collector to the 100 mm dust port
- Includes solid telescopic arm and square table which can be moved longitudinally
- Anodized aluminium sliding table with hardened guide rails
- Extractable telescopic fence, mountable at front or rear of square table
- Handwheel and scale allow for up to 45° sawblade tilt
- Part of equipment are table extension and enlargement for better support of larger panels
- Large, grey cast-iron machine table, built with top accuracy and polished surfaces
- Powerful drive motor for constant cutting speed, even at cutting height of 75 mm
- Aluminium rip fence with fine adjustment and precise round rod guide (30 mm)



Steplessly tiltable telescopic arm (2 x 45°) can be mounted at front or rear of square table.



Complete with robust parallel fence, 30 mm round rod guide designed for heavy work loads.



Parallel fence with quick and fine adjustment for cutting width up to 620 mm.



Sawblade cover - with integrated dust port - connected at riving knife.



Ergonomic mounted handwheels allow for height adjustment and tilting of the saw unit.



Eccentric holder comes standard.



Technical data	FKS 1300 H	FKS 1600 H
Table size	790 x 350 mm	790 x 350 mm
Sliding table	1300 x 240 mm	1600 x 240 mm
Cutting length	1300 mm	1600 mm
Max. sawblade diameter	254 x 30 mm	254 x 30 mm
Max. cutting height 90° / 45°	75 / 60 mm	75 / 60 mm
Cutting width on rip fence	620 mm	620 mm
Table height	815 mm	815 mm
Table extension	350 x 350 mm	350 x 350 mm
Table enlargement	790 x 270 mm	790 x 270 mm
Square table	600 x 480 mm	600 x 480 mm
Speed main sawblade	4000 rpm	4000 rpm
Dust extraction outlet	100 mm	100 mm
Motor power output S ₁ 100%	2,2 kW (3,0 HP)	2,2 kW (3,0 HP)
Motor power input S ₆ 40%	3,0 kW (4,0 HP)	3,0 kW (4,0 HP)
Voltage	230 V or 400 V	230 V or 400 V
Machine dimension (W x D x H)	1300 x 1700 x 1000 mm	1600 x 1700 x 1000 mm
Weight approx.	140 kg	150 kg
Art. no.	09-1098 (230 V) 09-1099 (400 V)	09-1100 (230 V) 09-1101 (400 V)

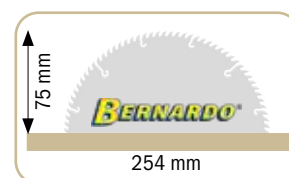

Standard accessories:

- Carbide sawblade 254 x 3 x 30 mm / 40T
- Protective cover with dust extraction outlet
- Connector tube with Y-piece
- Eccentric holder
- End stop
- Table extension
- Table enlargement
- Extractable telescopic fence
- Stop
- Square table
- Push stick
- Tools

The FKS 1300 H / FKS 1600 H is the ideal sliding table saw for the price-conscious experienced amateur. State-of-the-art technical solutions such as compact dimensions, high performance and user-friendly operation make this model unique. Complete with aluminium sliding table and solid square table to allow for processing of large panels.

FKS 1300 H FKS 1600 H



Extractable telescopic fence up to 1900 mm and stop featuring fine adjustment.



The smooth running sliding table features an additional tilting support arm to allow for processing of large panels.

Solid construction



VOLTAGE
Alternatively in
230 V or 400 V

Optional accessories:	Art. no.	excl. VAT
Set of sawblades (3 pcs.) 250 mm, in aluminium case	17-1651	
Dust collector DC 250 CF / 230 V	12-2085	
Dust collector DC 300 / 400 V	12-2045	

Optional accessories:	Art. no.	excl. VAT
PU-tube diam 100 mm (6 m)	12-1077	
Automatic start-up ALV 10 / 1 M	12-1150	
Automatic start-up ALV 2 / M 230 - 230 V	12-1152	

Sliding table saws

STS 1300 eco

STS 1600 eco

- Complete with aluminium sliding table with a surface of 1300 x 240 mm or 1600 x 240 mm
- Powerful motor guarantees optimal cutting results even at continuous operation
- Part of equipment are table extension and enlargement for better support of larger panels
- Ensure optimal work conditions by connecting a dust collector to the 100 mm dust port
- Handwheel and scale allow for up to 45° sawblade tilt
- Solid grey cast-iron table features T-slot for the mitre fence
- Large, grey cast-iron machine table, built with top accuracy and polished surfaces
- Torsion-free, steel and grey cast-iron machine body
- All aluminium parts (sliding table, fences,...) are anodized
- Complete with table extension for convenient cutting of large panels



Amplly sized square table, the steplessly tiltable aluminium fence (2x 45°) can be mounted on the front or rear.



The magnifying glass on the rip fence ensures an easy read out of mm-scale hence allowing precise adjustment of cutting width.



Includes easily adjustable rip fence with quick clamping system and table extension for cutting width up to 690 mm.



Sawblade cover - with integrated dust port - connected at riving knife.



Ergonomic mounted handwheels allow for height adjustment and tilting of the saw unit.



The sliding table features a generous size and runs smoothly on hardened prism guide ways.



Technical data	STS 1300 eco	STS 1600 eco
Table size	670 x 310 mm	670 x 310 mm
Sliding table	1300 x 240 mm	1600 x 240 mm
Cutting length	1300 mm	1600 mm
Max. sawblade diameter	254 x 30 mm	254 x 30 mm
Max. cutting height 90° / 45°	80 / 63 mm	80 / 63 mm
Cutting width on rip fence	690 mm	690 mm
Table height	870 mm	870 mm
Table extension	325 x 310 mm	325 x 310 mm
Table enlargement	670 x 400 mm	670 x 400 mm
Square table	600 x 455 mm	600 x 455 mm
Speed main sawblade	4750 rpm	4750 rpm
Dust extraction outlet	100 mm	100 mm
Motor power output S ₁ 100%	2,2 kW (3,0 HP)	2,2 kW (3,0 HP)
Motor power input S ₆ 40%	3,0 kW (4,0 HP)	3,0 kW (4,0 HP)
Voltage	230 V or 400 V	230 V or 400 V
Machine dimension (W x D x H)	1300 x 2160 x 1130 mm	1600 x 2160 x 1130 mm
Weight approx.	135 kg	140 kg
Art. no.	09-1082 (230 V) 09-1083 (400 V)	09-1086 (230 V) 09-1087 (400 V)

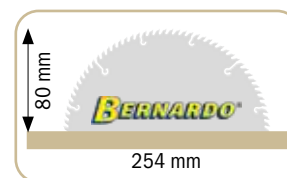

Standard accessories:

- Carbide sawblade 254 x 3,2 x 30 mm / 24T
- Protective cover with dust extraction outlet
- Connector tube with Y-piece
- Mitre fence with eccentric holder
- Mitre fence
- End stop
- Table extension
- Table enlargement
- Square table
- Push stick
- Tools

The STS sliding table saw is available with a table length of 1300 mm or 1600 mm. Part of the standard equipment is a 2,2 kW motor and a sawblade (diameter 254 mm) for cutting height up to 80 mm. Most commonly this model is used among craftsmen and in small businesses as a second machine.

STS 1300 eco STS 1600 eco



Sawblade can be tilted from 90° to 45° for precise angle cuts.



Mitre fence – featuring end stop and eccentric holder – movable along entire table length.

VOLTAGE

Alternatively in
230 V or 400 V

BEST PRICE!



BERNARDO
SEMIPROFESSIONAL

Powder coated

Optional accessories:

	Art. no.	excl. VAT
Set of sawblades (3 pcs.) 250 mm, in aluminium case	17-1651	
Dust collector DC 250 CF / 230 V	12-2085	
Dust collector DC 300 / 400 V	12-2045	

Optional accessories:

	Art. no.	excl. VAT
PU-tube diam 100 mm (6 m)	12-1077	
Automatic start-up ALV 10 / 1 M	12-1150	
Automatic start-up ALV 2 / M 230 - 230 V	12-1152	

Sliding table saws

FKS 1250 N

FKS 1600 N

- Smooth running, precise sliding table with hardened, prism-shaped guide
- Solid square table for operating on heavy, large panels
- Large, grey cast-iron machine table, built with top accuracy and polished surfaces
- Extractable, anodized aluminium telescopic fence with solid end stop
- Torsion-free, steel and grey cast-iron machine body
- Handwheel allows for tilting of saw unit up to 45°
- Solid saw unit minimizes vibrations significantly
- Complete with table extensions and enlargement for better support of large panels
- Aluminium rip fence with fine adjustment and precise round rod guide (30 mm)
- All aluminium parts (sliding table, fences,...) are anodized
- Includes solid telescopic arm and square table which can be moved longitudinally
- Powerful drive motor for constant cutting speed, even at cutting height of 80 mm

**Solid
construction**



Steplessly tiltable telescopic arm (2 x 45°) can be mounted at front or rear of square table.



Amplly sized work table and table extension for cutting width of up to 610 mm come standard.

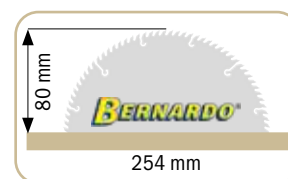

Handwheels allow for hassle-free, smooth adjustment of saw unit.



Hardened prism-shaped guide for smooth running of sliding table.



Complete with robust parallel fence, 30 mm round rod guide designed for heavy work loads.



BERNARDO
www.bernardo.at
SEMIPROFESSIONAL

Technical data	FKS 1250 N	FKS 1600 N
Table size	800 x 350 mm	800 x 350 mm
Sliding table	1320 x 240 mm	1610 x 240 mm
Cutting length	1250 mm	1600 mm
Max. sawblade diameter	254 x 30 mm	254 x 30 mm
Max. cutting height 90° / 45°	80 / 54 mm	80 / 54 mm
Cutting width on rip fence	610 mm	610 mm
Table height	860 mm	860 mm
Table extension	350 x 410 mm	350 x 410 mm
Table enlargement	800 x 270 mm	800 x 270 mm
Square table	600 x 460 mm	600 x 460 mm
Speed main sawblade	4060 rpm	4060 rpm
Dust extraction outlet	100 mm	100 mm
Motor power output S ₁ 100%	1,5 kW (2,0 HP)	1,5 kW (2,0 HP)
Motor power input S ₆ 40%	2,1 kW (2,8 HP)	2,1 kW (2,8 HP)
Voltage	230 V or 400 V	230 V or 400 V
Machine dimension (W x D x H)	1350 x 2100 x 1200 mm	1610 x 2100 x 1200 mm
Weight approx.	160 kg	170 kg
Art. no.	09-1092 (230 V) 09-1093 (400 V)	09-1094 (230 V) 09-1095 (400 V)

BEST PRICE!

Standard accessories:

- Carbide sawblade 254 x 3,0 x 30 mm / 36T
- Protective cover with dust extraction outlet
- Connector tube with Y-piece
- End stop
- Table extension
- Table enlargement
- Extractable telescopic fence
- Stop
- Square table
- Push stick
- Tools

The FKS 1250 N and FKS 1600 N sliding table saws meet the requirements of professional users, such as precision, high work comfort, short conversion time and versatility. Characteristics include high quality finish, smooth-running sliding table plus rip fence featuring round rod guide and fine adjustment.

FKS 1250 N FKS 1600 N



Sawblade cover - with integrated dust port - connected at riving knife.

VOLTAGE

Alternatively in
230 V or 400 V



Equipped with anodized aluminium sliding table to ensure high work comfort.



**Best
Price**

Powder coated

Optional accessories:

	Art. no.	excl. VAT
Set of sawblades (3 pcs.) 250 mm, in aluminium case	17-1651	
Dust collector DC 250 CF / 230 V	12-2085	
Dust collector DC 300 / 400 V	12-2045	

Optional accessories:

	Art. no.	excl. VAT
PU-tube diam 100 mm (6 m)	12-1077	
Automatic start-up ALV 10 / 1 M	12-1150	
Automatic start-up ALV 2 / M 230 - 230 V	12-1152	

Sliding table saw

STS 1360 STS 1600

- Complete with aluminium sliding table with a surface of 1360 x 240 mm or 1600 x 240 mm
- Powerful motor guarantees optimal cutting results even at continuous operation
- Part of equipment are table extension and enlargement for better support of larger panels
- Sawblade tilttable from 90° to 45° to allow for precise angle cuts
- Ensure optimal work conditions by connecting a dust collector to the 100 mm dust port
- Includes solid telescopic fence and longitudinally adjustable square table
- Handwheel and scale allow for up to 45° sawblade tilt
- Solid grey cast-iron table features T-slot for the mitre fence
- Extractable telescopic fence, steplessly tilttable from 90° - 45°
- Hardened prism-shaped guide for smooth running of sliding table
- Square table ensures convenient machining of large boards



Generously sized square table for support of large panel.



Complete with robust parallel fence, 25 mm round rod guide designed for heavy work loads.



VOLTAGE
Alternatively in
230 V or 400 V



Ergonomic mounted handwheels allow for height adjustment and tilting of the saw unit.



Torsion-free aluminium sliding table features smooth guiding to guarantee precise working.



Solid saw unit features grey-cast iron tilting elements supported on both sides.

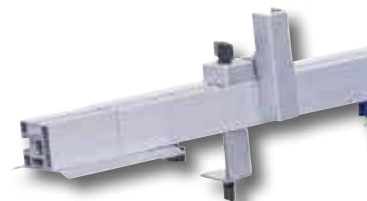

Technical data	STS 1360	STS 1600
Table size	760 x 350 mm	760 x 350 mm
Sliding table	1360 x 240 mm	1600 x 240 mm
Cutting length	1360 mm	1600 mm
Max. sawblade diameter	315 x 30 mm	315 x 30 mm
Max. cutting height 90° / 45°	100 / 75 mm	100 / 75 mm
Cutting width on rip fence	900 mm	900 mm
Table height	870 mm	870 mm
Table extension	500 x 350 mm	500 x 350 mm
Table enlargement	760 x 600 mm	760 x 600 mm
Square table	600 x 410 mm	600 x 410 mm
Speed main sawblade	4250 rpm	4250 rpm
Dust extraction outlet	100 mm	100 mm
Motor power output S ₁ 100%	2,2 kW (3,0 HP)	2,2 kW (3,0 HP)
Motor power input S ₆ 40%	3,0 kW (4,0 HP)	3,0 kW (4,0 HP)
Voltage	230 V or 400 V	230 V or 400 V
Machine dimension (W x D x H)	1700 x 2500 x 1270 mm	2000 x 2500 x 1270 mm
Weight approx.	194 kg	204 kg
Art. no.	09-10958(230 V) 09-10959 (400 V)	09-1097 (230 V) 09-1096 (400 V)



The smooth running sliding table features an additional tilting support arm to allow for processing of large panels.

Standard accessories:

- Carbide sawblade 315 x 3,2 x 30 mm / 24T
- Protective cover with dust extraction outlet
- Connector tube with Y-piece
- End stop
- Table extension
- Table enlargement
- Extractable telescopic fence
- Stop with loupe
- Square table
- 2x Push stick
- Tools

The STS 1360 / STS 1600 is the ideal sliding table saw for the price-conscious experienced amateur. State-of-the-art technical solutions such as compact dimensions, high performance and user-friendly operation make this model unique. Complete with aluminium sliding table and solid square table to allow for processing of large panels.

STS 1360 STS 1600



Parallel fence with quick and fine adjustment for cutting width up to 900 mm.

**Best
Price**



Extractable telescopic fence, mountable at front and rear of square table.



Optional accessories:

Set of sawblades (3 pcs.) 315 mm, in aluminium case
Dust collector DC 300 / 400 V
Dust collector DC 400 / 230 V
Dust collector DC 400 / 400 V

Art. no.	excl. VAT
17-1653	
12-2045	
12-2055	
12-2060	

Optional accessories:

PU-tube diam. 100 mm (6 m)
Automatic start-up ALV 10 / 1 M
Automatic start-up ALV 2 / M 230 - 230 V
Digital angle finder

Art. no.	excl. VAT
12-1077	
12-1150	
12-1152	
31-1044	

Sliding table saws

TK 315 P - 1600 TK 315 P - 1800

- Important feature: Sawblade diameter 315 mm can be used when scoring unit is mounted
- Solid square table with roller and telescopic arm guarantee high stability
- Anodized aluminium sliding table available in three lengths
- Powerful drive motor for constant cutting speed, even at cutting height of 100 mm
- Mitre fence and downholder can be moved along entire table length
- Amply sized work table and table extensions for cutting width up to 1240 mm come standard
- Extractable telescopic fence (up to 2260 mm) mountable at front or rear of square table, steplessly tiltable from 90° to 45°
- Aluminium parallel fence with micrometric fine adjustment and integrated magnifying glass
- Solid saw unit guarantees precise work, free from vibrations



Ergonomically arranged handwheels on machine body allow for saw unit adjustment.



The magnifying glass on the rip fence ensures an easy read out of mm-scale hence allowing precise adjustment of cutting width.

Square table
with roll

Standard accessories:

- Carbide sawblade 315 x 3,0 x 30 mm / 40T
- Scoring sawblade 90 x 3,0 x 20 mm / 12T
- Protective cover with dust extraction outlet
- Connector tube with Y-piece
- Mitre fence with eccentric holder
- Mitre fence
- End stop
- Table extension
- Table enlargement
- Extractable telescopic fence
- Stop with fine adjustment
- Square table with roller
- Push stick
- Tools



Serially with
scoring unit

Technical data	TK 315 P - 1600	TK 315 P - 1800	TK 315 P - 2000
Table size	825 x 800 mm	825 x 800 mm	825 x 800 mm
Sliding table	1600 x 270 mm	1800 x 270 mm	2000 x 270 mm
Cutting length	1600 mm	1800 mm	2000 mm
Max. sawblade diameter	315 x 30 mm	315 x 30 mm	315 x 30 mm
Max. cutting height 90° / 45°	100 / 80 mm	100 / 80 mm	100 / 80 mm
Cutting width on rip fence	1240 mm	1240 mm	1240 mm
Table height	870 mm	870 mm	870 mm
Table extension	500 x 310 mm	500 x 310 mm	500 x 310 mm
Table enlargement	800 x 440 mm	800 x 440 mm	800 x 440 mm
Square table with roll	700 x 580 mm	700 x 580 mm	700 x 580 mm
Speed main sawblade	4000 rpm	4000 rpm	4000 rpm
Speed scoring sawblade	5800 rpm	5800 rpm	5800 rpm
Scoring sawblade	90 x 20 mm	90 x 20 mm	90 x 20 mm
Dust extraction outlet	100 mm	100 mm	100 mm
Motor power output S ₁ 100%	3,0 kW (4,0 HP)	3,0 kW (4,0 HP)	3,0 kW (4,0 HP)
Motor power input S ₆ 40%	4,2 kW (5,7 HP)	4,2 kW (5,7 HP)	4,2 kW (5,7 HP)
Voltage	230 V or 400 V	230 V or 400 V	230 V or 400 V
Machine dimension (W x D x H)	1600 x 2870 x 1140 mm	1800 x 2870 x 1140 mm	2000 x 2870 x 1140 mm
Weight approx.	238 kg	248 kg	258 kg
Art. no.	09-1108 (230 V) 09-11080 (400 V)	09-11081 (230 V) 09-11082 (400 V)	09-11083 (230 V) 09-11084 (400 V)

The TK 315 P sliding table saw is available with a table length of 1600 mm / 1800 mm or 2000 mm. Part of the standard equipment is a 3.0 kW motor, a sawblade (diameter 315 mm) for cutting height up to 100 mm and scoring unit for smooth processing of coated materials.

TK 315 P - 2000



Handwheel allows for saw unit (tiltable up to 45°) to be set to a cutting height of up to 100 mm.



Extractable telescopic fence up to 2260 mm and stop featuring fine adjustment.



The sliding table features a generous size and runs smoothly on hardened prism guide ways.



BERNARDO
SEMIPROFESSIONAL

Optional accessories:

	Art. no.	excl. VAT
Set of sawblades (3 pcs.) 250 mm, in aluminium case	17-1651	
Set of sawblades (3 pcs.) 315 mm, in aluminium case	17-1653	
Scoring sawblade 90 x 20 x 3 mm	17-1603	
Dust collector DC 300 / 400 V	12-2045	
Dust collector DC 400 / 230 V	12-2055	

Optional accessories:

	Art. no.	excl. VAT
Dust collector DC 400 / 400 V	12-2060	
PU-tube diam. 100 mm (6 m)	12-1077	
Automatic start-up ALV 10 / 1 M	12-1150	
Automatic start-up ALV 2 / M 230 - 230 V	12-1152	
Digital angle finder	31-1044	

Sliding table saw

Basic 2000 Pro

- Aluminium sliding table with hardened guide rails
- Solid square table allows processing of large or heavy panels
- Part of equipment are table extensions and enlargement for better support of larger panels
- Mitre fence and eccentric holder can be moved along entire length of sliding table
- Solid saw unit guarantees precise work free from vibrations
- Machine body consists of torsion-free combination of steel and grey cast-iron
- Extractable telescopic fence (max. 2260 mm), mountable on front or rear of square of table
- Parallel fence can be folded down and includes micrometric fine adjustment (advantage for large panels)
- Handwheel and scale allow for up to a 45° sawblade tilt
- Powerful motor guarantees optimal cutting capacity even at continuous operation
- Large grey cast-iron machine table, accurately manufactured and polished

Square table with roll

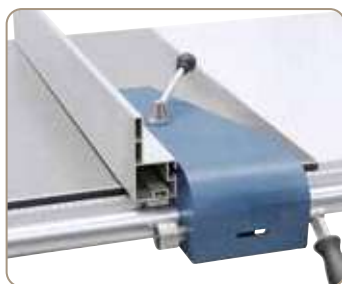

Complete with robust parallel fence, 40 mm round rod guide designed for heavy work loads.



The amply sized sliding table runs smoothly and maintenance-free on hardened prism-shaped guide.



Amply sized work table includes table extension for cutting width up to 1200 mm.

Standard accessories:

- Carbide sawblade 315 x 3,0 x 30 mm / 40T
- Scoring sawblade 90 x 20 mm / 12T
- Protective sawblade cover with dust extraction outlet
- Connector hose with Y-piece
- Mitre fence with eccentric holder
- Mitre fence
- End stop
- Table extension
- Table enlargement
- Extractable telescopic fence
- Stop with fine adjustment
- Square table with roll
- Push stick
- Tools

Serially with scoring unit



Technical data

Basic 2000 Pro

Table size	800 x 385 mm
Sliding table	2000 x 270 mm
Cutting length	2000 mm
Max. sawblade diameter	315 x 30 mm
Max. cutting height 90° / 45°	100 / 80 mm
Cutting width on rip fence	1200 mm
Table height	860 mm
Table extension	500 x 310 mm
Table enlargement	800 x 880 mm
Square table with roll	755 x 580 mm
Speed main sawblade	4000 rpm
Speed scoring sawblade	5800 rpm
Scoring sawblade	90 x 20 mm
Dust extraction outlet	100 mm
Motor power output S ₁ 100%	3,8 kW (5,1 HP)
Motor power input S ₆ 40%	5,3 kW (7,2 HP)
Voltage	400 V
Machine dimension (W x D x H)	2000 x 2800 x 1140 mm
Weight approx.	270 kg
Art. no.	09-1129



The Basic 2000 Pro sliding table saw features a tiltable sawblade and comes equipped with a scoring unit to meet the requirements of professional users. State-of-the-art technical solutions, such as high user comfort, powerful drive as well as smooth running sliding table are only some of the highlights of this model.

Basic 2000 Pro



Square table with roll ensures convenient machining of large workpieces.

BERNARDO
www.bernardo.at
SEMIPROFESSIONAL



The protective sawblade cover with integrated dust port is connected at riving knife. Standard equipment includes a scoring unit.



BEST PRICE!

Optional accessories:

	Art. no.	excl. VAT
Set of sawblades (3 pcs.) 315 mm, in aluminium case	17-1653	
Scoring sawblade 90 x 20 mm	17-1603	
Dust collector DC 300 / 400 V	12-2045	

Optional accessories:

	Art. no.	excl. VAT
Dust collector DC 400 / 400 V	12-2060	
PU-tube diam 100 mm (6 m)	12-1077	
Automatic start-up ALV 10 / 1 M	12-1150	

Sliding table saws

Basic Pro - Serie

- Solid square table helps support large and heavy panels
- Extractable telescopic fence (up to 2260 mm), mountable at front or rear of square table
- Powerful drive motor guarantees optimal cutting capacity even at continuous operation
- Mitre fence and downholder can be moved along the entire sliding table length
- Complete with table extensions and enlargement for better support of large panels
- Solid saw unit guarantees accurate work free from vibrations
- Aluminium sliding table features hardened guide rails
- Machine body consists of torsion-free combination of steel and grey cast-iron
- Large grey cast-iron table, designed with top precision and polished finish
- Parallel fence can be folded down and includes micrometric fine adjustment (advantage for large panels)
- Handwheel and scale allows for sawblade tilt of up to 45°

**Best
Price**



The up to 45° tiltable saw unit can be set for cutting heights of up to 100 mm by using the handwheel.



Mitre fence – featuring end stop and eccentric holder – movable along entire table length.



Standard accessories:

- Carbide sawblade 315 x 3,0 x 30 mm / 40T
- Scoring sawblade 90 x 20 mm / 12T
- Protective cover with dust extraction outlet
- Connector hose with Y-piece
- Mitre fence with eccentric holder
- Mitre fence
- End stop
- Table extension
- Table enlargement
- Extractable telescopic fence
- Stop with fine adjustment
- Square table with roll
- Push stick
- Tools

**Square table
with roll**



**Serially with
scoring unit**

Technical data	Basic 2600 Pro	Basic 2800 Pro	Basic 3200 Pro
Table size	800 x 385 mm	800 x 385 mm	800 x 385 mm
Sliding table	2600 x 270 mm	2800 x 270 mm	3200 x 270 mm
Cutting length	2600 mm	2800 mm	3300 mm
Max. sawblade diameter	315 x 30 mm	315 x 30 mm	315 x 30 mm
Max. cutting height 90° / 45°	100 / 80 mm	100 / 80 mm	100 / 80 mm
Cutting width on rip fence	1200 mm	1200 mm	1200 mm
Table height	860 mm	860 mm	860 mm
Table extension	500 x 310 mm	500 x 310 mm	500 x 310 mm
Table enlargement	800 x 880 mm	800 x 880 mm	800 x 880 mm
Square table with roll	755 x 580 mm	755 x 580 mm	935 x 580 mm
Speed main sawblade	4000 rpm	4000 rpm	4000 rpm
Speed scoring sawblade	5800 rpm	5800 rpm	5800 rpm
Scoring sawblade	90 x 20 mm	90 x 20 mm	90 x 20 mm
Dust extraction outlet	100 mm	100 mm	100 mm
Motor power output S ₁ 100%	3,8 kW (5,1 HP)	3,8 kW (5,1 HP)	3,8 kW (5,1 HP)
Motor power input S ₆ 40%	5,3 kW (7,2 HP)	5,3 kW (7,2 HP)	5,3 kW (7,2 HP)
Voltage	400 V	400 V	400 V
Machine dimension (W x D x H)	2600 x 2810 x 1140 mm	2800 x 2820 x 1140 mm	3200 x 2990 x 1140 mm
Weight approx.	300 kg	306 kg	312 kg
Art. no.	09-1130	09-1131	09-1132

The sliding table saws of the Basics Pro-series feature a tiltable saw blade and come complete with a scoring unit to meet the high demands of professional users. Sophisticated technical aspects such as the high user comfort, powerful drive and the smoothly running sliding table make these models stand out.

Basic Pro - Serie



Parallel fence with solid round rod guide (40 mm) can be used for cutting width of up to 1200 mm.



Complete with scoring unit for burr-free processing of panels.



Extractable telescopic fence (up to 2260 mm) complete with precisely adjustable end stop.



Optional accessories:

Set of sawblades (3 pcs.) 315 mm, in aluminium case	Art. no.	excl. VAT
Scoring sawblade 90 x 20 mm	17-1653	
Dust collector DC 500 E / 400 V	17-1603	
	12-2066	

Optional accessories:

Dust collector ASA 3500 / 400 V	Art. no.	excl. VAT
PU-tube diam 100 mm (6 m)	12-2080	
Automatic start-up ALV 10 / 1 M	12-1077	
	12-1150	

Sliding table saws

FKS Pro - Serie

- Extractable telescopic fence (up to 2260 mm) mountable at front or rear of square table, steplessly tiltable from 90° to 45°
- Important feature: Sawblade diameter 315 mm can be used when scoring unit is mounted
- Amply sized work table and table extensions for cutting width up to 1200 mm come standard
- Powerful drive motor for constant cutting speed, even at cutting height of 100 mm
- Mitre fence and downholder can be moved along entire table length
- Aluminium parallel fence with micrometric fine adjustment and integrated magnifying glass
- Solid saw unit guarantees precise work, free from vibrations
- Solid square table with roller and telescopic arm guarantee high stability
- Anodized aluminium sliding table available in two lengths



Complete with scoring unit for burr-free processing of panels.



The amply sized sliding table runs smoothly and maintenance-free on hardened prism-shaped guide.



Easy adjustment of the mitre fence by a scale incorporated in the table



Practically positioned handwheel guarantees quick and easy sawblade height adjustment.



Tiltable parallel fence with micro-metric fine adjustment (advantage with large panels).



BEST PRICE!

**Square table
with roll**

**Serially with
scoring unit**

Technical data	FKS 1600 Pro	FKS 2000 Pro
Table size	800 x 380 mm	800 x 380 mm
Sliding table	1600 x 270 mm	2000 x 270 mm
Cutting length	1600 mm	2000 mm
Max. sawblade diameter	315 x 30 mm	315 x 30 mm
Max. cutting height 90° / 45°	100 / 80 mm	100 / 80 mm
Cutting width on rip fence	1200 mm	1200 mm
Table height	870 mm	870 mm
Table extension	500 x 310 mm	500 x 310 mm
Table enlargement	800 x 880 mm	800 x 880 mm
Square table with roller	700 x 580 mm	700 x 580 mm
Speed main sawblade	4000 rpm	4000 rpm
Speed scoring sawblade	5800 rpm	5800 rpm
Scoring sawblade	90 x 20 mm	90 x 20 mm
Dust extraction outlet	100 mm	100 mm
Motor power output S ₁ 100%	3,8 kW (5,1 HP)	3,8 kW (5,1 HP)
Motor power input S ₆ 40%	5,3 kW (7,2 HP)	5,3 kW (7,2 HP)
Voltage	400 V	400 V
Machine dimension (W x D x H)	1700 x 2800 x 1180 mm	2000 x 2900 x 1180 mm
Weight approx.	255 kg	280 kg
Art. no.	09-1124	09-1125



Standard accessories:

- Carbide sawblade 315 x 3,0 x 30 mm / 40T
- Scoring sawblade 90 x 3,0 x 20 mm / 12T
- Protective cover with dust extraction outlet
- Connector hose with Y-piece
- Mitre fence with eccentric holder
- Mitre fence
- End stop
- Table extension
- Table enlargement
- Rip fence
- Extractable telescopic fence
- Stop with fine adjustment
- Square table
- Push handle
- Push stick
- Tools

Many cutting tasks require the use of small and precise circular saws. The machines are often used in addition to large sliding table saws and ask for the same requirements such as precision, high user comfort, short conversion time and versatility. The BERNARDO circular saws FKS 1600 Pro and FKS 2000 Pro meet all these demands without sacrificing the aluminium sliding table which offers a lot of convenience when processing smaller workpieces.

FKS Pro - Serie



25 mm round rod allows for precise guiding of aluminium parallel fence.



Square table with roll ensures convenient machining of large workpieces.



The amply dimensioned work table includes table extension for cutting width up to 1200 mm.



Optional accessories:

Scoring sawblade 90 x 20 x 3 mm	Art. no.	excl. VAT
Set of sawblades (3 pcs.) 315 mm, in aluminium case	17-1603	
Carbide sawblade 315 x 3,2 x 30 mm, 72T	17-1653	
	18-1001	
Dust collector DC 500 E / 400 V	12-2066	

Optional accessories:

PVC-tube diam. 100 mm (10 m)	Art. no.	excl. VAT
PU-tube diam. 100 mm (6 m)	12-1070	
Automatic start-up ALV 10 / 1 M	12-1077	
Digital angle finder	12-1150	
	31-1044	

Sliding table saws

FKS Pro - Serie

- Important feature: Sawblade diameter 315 mm can be used when scoring unit is mounted
- Solid square table with roller and telescopic arm guarantee high stability
- Anodized aluminium sliding table available in three lengths
- Powerful drive motor for constant cutting speed, even at cutting height of 100 mm
- Mitre fence and downholder can be moved along entire table length
- Amply sized work table and table extensions for cutting width up to 1200 mm come standard
- Extractable telescopic fence (up to 2260 mm) mountable at front or rear of square table, steplessly tiltable from 90° to 45°
- Aluminium parallel fence with micrometric fine adjustment and integrated magnifying glass
- Solid saw unit guarantees precise work, free from vibrations



Sawblade cover, featuring integrated dust port, connected to riving knife. Standard equipment includes scoring unit.



Practically positioned handwheel guarantees quick and easy sawblade height adjustment.



Tiltable parallel fence with micro-metric fine adjustment (advantage with large panels).

**Square table
with roll**

**Serially with
scoring unit**

Standard accessories:

- Carbide sawblade 315 x 3,0 x 30 mm / 40T
- Scoring sawblade 90 x 3,0 x 20 mm / 12T
- Protective cover with dust extraction outlet
- Connector hose with Y-piece
- Mitre fence with eccentric holder
- Mitre fence
- End stop
- Table extension
- Table enlargement
- Rip fence
- Extractable telescopic fence
- Stop with fine adjustment
- Square table
- Push handle
- Push stick
- Tools



Technical data	FKS 2600 Pro	FKS 2800 Pro	FKS 3200 Pro
Table size	800 x 380 mm	800 x 380 mm	800 x 380 mm
Sliding table	2600 x 270 mm	2800 x 270 mm	3200 x 270 mm
Cutting length	2600 mm	2800 mm	3200 mm
Max. sawblade diameter	315 x 30 mm	315 x 30 mm	315 x 30 mm
Max. cutting height 90° / 45°	100 / 80 mm	100 / 80 mm	100 / 80 mm
Cutting width on rip fence	1200 mm	1200 mm	1200 mm
Table height	870 mm	870 mm	870 mm
Table extension	500 x 310 mm	500 x 310 mm	500 x 310 mm
Table enlargement	800 x 880 mm	800 x 880 mm	800 x 880 mm
Square table with roller	700 x 580 mm	880 x 580 mm	880 x 580 mm
Speed main sawblade	4000 rpm	4000 rpm	4000 rpm
Speed scoring sawblade	5800 rpm	5800 rpm	5800 rpm
Scoring sawblade	90 x 20 mm	90 x 20 mm	90 x 20 mm
Dust extraction outlet	100 mm	100 mm	100 mm
Motor power output S ₁ 100%	3,8 kW (5,1 HP)	3,8 kW (5,1 HP)	3,8 kW (5,1 HP)
Motor power input S ₆ 40%	5,3 kW (7,2 HP)	5,3 kW (7,2 HP)	5,3 kW (7,2 HP)
Voltage	400 V	400 V	400 V
Machine dimension (W x D x H)	2600 x 2900 x 1180 mm	2800 x 2900 x 1180 mm	3200 x 3860 x 1180 mm
Weight approx.	318 kg	324 kg	330 kg
Art. no.	09-1126	09-1127	09-1128

The FKS-series sliding table saws are available with a table length of 2600, 2800 or 3200 mm. Part of the standard equipment is a 3.8 kW motor, a sawblade (diameter 315 mm) for cutting height up to 100 mm and scoring unit for smooth processing of coated materials.

FKS Pro - Serie



Parallel fence with solid round rod guide (40 mm) can be used for cutting width of up to 1200 mm.



Mitre fence for small workpieces, movable along entire table length.



The steplessly tiltable telescopic fence (2x 45°) can be mounted at the front or rear of the square table.



BEST PRICE!

BERNARDO
SEMIPROFESSIONAL

Optional accessories:

	Art. no.	excl. VAT
Scoring sawblade 90 x 20 x 3 mm	17-1603	
Set of sawblades (3 pcs.) 315 mm, in aluminium case	17-1653	
Carbide sawblade 315 x 3,2 x 30 mm, 72T	18-1001	
Dust collector DC 500 E / 400 V	12-2066	

Optional accessories:

	Art. no.	excl. VAT
PVC-tube diam. 100 mm (10 m)	12-1070	
PU-tube diam. 100 mm (6 m)	12-1077	
Automatic start-up ALV 10 / 1 M	12-1150	
Digital angle finder	31-1044	

Sliding table saw

Procut 3200 P

- Serially equipped with a digital indication of the adjusted cutting angle
- Aluminium sliding table features hardened guide rails
- Table extension and enlargement for supporting large panels come standard
- Solid square table for machining of large, heavy panels without needing extra support
- Powerful drive motor guarantees optimal cutting capacity even at continuous operation
- Parallel fence with solid 40 mm round rod guide can be tilted away
- Scoring unit with independent motor comes standard
- Solid saw unit guarantees precise processing, free from vibrations
- Torsion-free machine body is a combination of steel and grey cast-iron
- Mitre fence and downholder can be moved along entire table length



Parallel fence with solid round rod guide can be used for cutting width of up to 1350 mm.



When cutting large pieces, parallel fence can be tilted down.



Square table can be moved along the entire sliding table length and taken off at any position. The telescopic fence, featuring 2 solid tiltable stops, allows precise adjustments.



User-friendly height and side adjustment of scoring unit.

BERNARDO
www.bernardo.at
SEMIPROFESSIONAL



Square table with roll

Technical data

Procut 3200 P

Table size	935 x 600 mm
Sliding table	3200 x 375 mm
Cutting length	3200 mm
Max. sawblade diameter	300 x 30 mm
Max. cutting height 90° / 45°	80 / 55 mm
Cutting width on rip fence	1350 mm
Table height	820 mm
Table extension	615 x 600 mm
Table enlargement	895 x 600 mm
Square table with roll	1200 x 860 mm
Speed main sawblade	4000 / 6000 rpm
Speed scoring sawblade	8000 rpm
Scoring sawblade	120 x 20 mm
Dust extraction outlet	100 mm
Motor power output S ₁ 100%	4,0 kW (5,5 HP)
Motor power input S ₆ 40%	5,5 kW (7,5 HP)
Motor scoring unit	0,75 kW
Voltage	400 V
Machine dimension (W x D x H)	3370 x 3470 x 1550 mm
Weight approx.	675 kg
Art. no.	09-11790

Standard accessories:

- Digital cutting angle indication
- Protective cover with infeed roller
- Mitre fence
- Eccentric holder
- Table extension
- Extractable telescopic fence
- Longitudinal stop
- Square table with roll
- Push stick
- Scoring unit with independent motor
- Tools

Serially with scoring unit

Digital cutting angle indication

The Procut 3200 P is a precise sliding table saw for professional users. The torsion-free machine body made of a steel and grey-cast iron combination and the solid saw unit with a powerful drive motor guarantee a smooth run and a constant cutting speed. Additional this machine is equipped with a digital cutting angle indication.

Procut 3200 P



Precise setting of the required cutting angle using a digital display.



Complete with scoring unit for burr-free processing of panels.



Torsion-free aluminium sliding table features smooth guiding to guarantee precise working.



Central lubrication for the main spindle comes standard.

Optional accessories:

Carbide sawblade 300 x 3,2 x 30 mm, 96T
Scoring sawblade 120 x 20 mm, 24T
Dust collector DC 500 E / 400 V

Art. no.	excl. VAT
18-1001A	
18-1004	
12-2066	

Optional accessories:

PVC-tube diam. 100 mm (10 m)
PU-tube diam. 100 mm (6 m)
Automatic start-up ALV 10 / 1 M

Art. no.	excl. VAT
12-1070	
12-1077	
12-1150	

Sliding table saws

Classic 1300 C Classic 1600 C

- Smoothly running, precise sliding table features hardened prism-shaped guide
- Square table with roll ensures user-friendly operation of large workpieces
- Powerful motor with high torque, designed for optimal cutting capacity
- Handwheel features scale for sawblade tilt up to 45°
- Telescopic fence complete with 2 end stops
- Solid saw unit, featuring grey cast-iron tilting elements, supported on both sides
- Table extension for cutting width up to 1295 mm part of equipment
- Parallel fence can be folded down and includes micrometric fine adjustment (advantage for large panels)
- Large, grey cast-iron table, designed and polished with high accuracy
- Complete with independently driven scoring unit (0.75 kW motor)



When cutting large pieces, parallel fence can be tilted down.



The amply sized sliding table runs smoothly and maintenance-free on hardened prism-shaped guide.



Parallel fence with micrometric fine adjustment can be used for cutting widths up to 1295 mm.



Sawblade cover, featuring integrated dust port, connected to riving knife. Standard equipment includes a scoring unit.



Square table can be moved along the entire sliding table length and taken off at any position. The telescopic fence, featuring 2 solid tiltable stops, allows precise adjustments.



Technical data	Classic 1300 C	Classic 1600 C
Table size	935 x 620 mm	935 x 620 mm
Sliding table	1300 x 360 mm	1600 x 360 mm
Cutting length	1300 mm	1600 mm
Max. sawblade diameter	315 x 30 mm	315 x 30 mm
Max. cutting height 90° / 45°	90 / 60 mm	90 / 60 mm
Cutting width on rip fence	1295 mm	1295 mm
Table height	850 mm	850 mm
Table extension	750 x 600 mm	750 x 600 mm
Square table with roll	725 x 550 mm	725 x 550 mm
Speed main sawblade	4000 / 6000 rpm	4000 / 6000 rpm
Speed scoring sawblade	8000 rpm	8000 rpm
Scoring sawblade	120 x 20 mm	120 x 20 mm
Dust extraction outlet	100 mm	100 mm
Motor power output S ₁ 100%	4,0 kW (5,5 HP)	4,0 kW (5,5 HP)
Motor power input S ₆ 40%	5,5 kW (7,5 HP)	5,5 kW (7,5 HP)
Motor scoring unit	0,75 kW	0,75 kW
Voltage	400 V	400 V
Machine dimension (W x D x H)	1550 x 2920 x 1560 mm	1680 x 3000 x 1520 mm
Weight approx.	530 kg	550 kg
Art. no.	09-1160B	09-1165B



Longitudinal fence stop can be used on both sides for accurate setting of cutting width on telescopic fence.

Standard accessories:

- Protective cover with infeed roller
- Mitre fence
- End stop
- Table extension
- Extractable telescopic fence
- Longitudinal stop
- Square table with roll
- Push stick
- Scoring unit with independent motor
- Tools

Many cutting tasks require the use of small and precise circular saws. The machines are often used in addition to large sliding table saws and ask for the same requirements such as precision, high user comfort, short conversion time and versatility. The BERNARDO circular saws Classic 1300 C and Classic 1600 C meet all these demands without sacrificing the aluminium sliding table which offers a lot of convenience when processing smaller workpieces.

Classic 1300 C Classic 1600 C



The T-slot on sliding table allow for mounting of several accessories, such as end stop, eccentric clamp, telescopic fence etc.



Handwheel with scale



Saw unit – tiltable up to 45° - can be adjusted by handwheel for cutting heights up to 90 mm.



Optional accessories:

- Sawblades diam. 315 mm, 3 pcs., in aluminium case
- Carbide sawblade 300 x 3,2 x 30 mm, 96T
- Scoring sawblade 120 x 20 mm, 24T
- Eccentric holder

Art. no.	excl. VAT
17-1653	
18-1001A	
18-1004	
09-1425	

Optional accessories:

- Dust collector DC 500 E / 400 V
- PVC-tube diam. 100 mm (10 m)
- PU-tube diam. 100 mm (6 m)
- Automatic start-up ALV 10 / 1 M

Art. no.	excl. VAT
12-2066	
12-1070	
12-1077	
12-1150	

Sliding table saws

Classic 2500 C Classic 3200 C

- Aluminium sliding table features hardened guide rails
- Table extension and enlargement for supporting large panels come standard
- Solid square table for machining of large, heavy panels without needing extra support
- Powerful drive motor guarantees optimal cutting capacity even at continuous operation
- User-friendly read of set angles directly at handwheel
- Scoring unit with independent motor comes standard
- Extractable telescopic fence (up to 3100 mm), mountable at front and rear of square table
- Solid saw unit guarantees precise processing, free from vibrations
- Torsion-free machine body is a combination of steel and grey cast-iron
- Parallel fence with solid 40 mm round rod guide can be tilted away

Serially with
scoring unit



The steplessly tiltable (2 x 45°) telescopic fence can be mounted at front or rear of square table.



Parallel fence with quick and fine adjustment for cutting width up to 1295 mm.



Solid saw unit features grey cast-iron tilting elements supported on both sides.



Excellent value
for money

Technical data	Classic 2500 C	Classic 3200 C
Table size	935 x 620 mm	935 x 620 mm
Sliding table	2500 x 370 mm	3200 x 370 mm
Cutting length	2500 mm	3200 mm
Max. sawblade diameter	315 x 30 mm	315 x 30 mm
Max. cutting height 90° / 45°	90 / 65 mm	90 / 65 mm
Cutting width on rip fence	1295 mm	1295 mm
Table height	850 mm	850 mm
Table extension	600 x 615 mm	600 x 615 mm
Table enlargement	900 x 600 mm	900 x 600 mm
Square table with roll	1210 x 860 mm	1210 x 860 mm
Speed main sawblade	4000 / 6000 rpm	4000 / 6000 rpm
Speed scoring sawblade	8000 rpm	8000 rpm
Scoring sawblade	120 x 20 mm	120 x 20 mm
Dust extraction outlet	100 mm	100 mm
Motor power output S ₁ 100%	4,0 kW (5,5 HP)	4,0 kW (5,5 HP)
Motor power input S ₆ 40%	5,5 kW (7,5 HP)	5,5 kW (7,5 HP)
Motor scoring unit	0,75 kW	0,75 kW
Voltage	400 V	400 V
Machine dimension (W x D x H)	2660 x 3460 x 1520 mm	3445 x 3560 x 1570 mm
Weight approx.	650 kg	710 kg
Art. no.	09-1170BXL	09-1175BXL

Standard accessories:

- Protective cover with infeed roller
- Mitre fence
- End stop
- Table extension
- Extractable telescopic fence
- Longitudinal stop
- Square table with roller
- Push stick
- Scoring unit with independent motor
- Tools

The Classic 2500 C and Classic 3200 C circular saws feature a tiltable sawblade, meet most demands of craftsmanship and are ideal models for price-conscious small to medium sized businesses. The robust construction and generous machine dimensions offer great working conditions when cutting solid timber and large material – even decorative panels can be cut by using the scoring unit (part of standard equipment).

Classic 2500 C Classic 3200 C



Picture shows optionally available pneumatic clamping device.

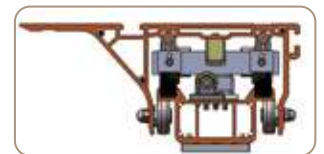

User-friendly height and side adjustment of scoring unit.



Optional accessories:

Sawblades diam. 315 mm, 3 pcs., in aluminium case	17-1653	Art. no.	excl. VAT
Carbide sawblade 300 x 3,2 x 30 mm, 96T	18-1001A		
Scoring sawblade 120 x 20 mm, 24T	18-1004		
Eccentric holder	09-1425		
Pneumatic clamp device f. Classic 2500 C	09-1425A		

Optional accessories:

Pneumatic clamp device f. Classic 3200 C	09-1426	Art. no.	excl. VAT
Dust collector DC 500 E / 400 V	12-2066		
PVC-tube diam. 100 mm (10 m)	12-1070		
PU-tube diam. 100 mm (6 m)	12-1077		
Automatic start-up ALV 10 / 1 M	12-1150		

Sliding table saw

Topcut 3200 ER

- Powerful drive motor (5.5 kW) features a high torque, designed for optimal cutting capacity
- Smooth running sliding table on double rollers locks at middle or end position for precise cuts
- Maximum sawblade diameter 400 mm for cutting height up to 125 mm
- Square table with roll for more convenience with large workpieces
- Tilttable parallel fence with micro-metric fine adjustment (advantage with large panels)
- Equipped with separately driven scoring unit (motor power 0.75 kW)
- Solid saw unit with grey cast iron tilting elements supported on both sides
- Table extension for cutting width up to 1300 mm
- All aluminium parts (square table, fences etc.) are anodized
- Extractable telescopic fence (up to 3200 mm) can be mounted at front or back of square table, stepless tilttable between 90° and 45°.

Serially with
scoring unit



Double roller system ensures a smooth and precise run.



Longitudinal stop usable on both sides and guarantees precise adjustment of cutting width on telescopic fence.



The amply sized square table can be moved along the entire cutting length and can be detached at any position. The extractable telescopic fence with 2 large tiltable stops can be adjusted precisely.



Solid saw unit features grey cast-iron tilting elements supported on both sides.

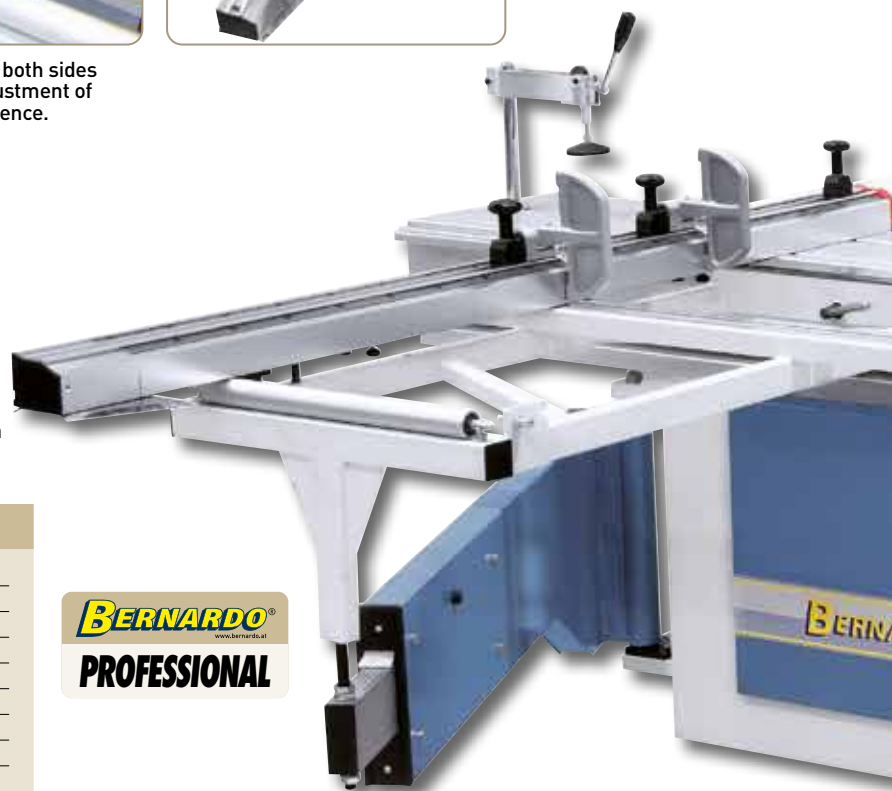

BERNARDO
www.bernardo.at
PROFESSIONAL

Technical data

Topcut 3200 ER

Table size	1100 x 735 mm
Sliding table	3200 x 400 mm
Cutting length	3200 mm
Max. sawblade diameter	400 x 30 mm
Max. cutting height 90° / 45°	125 / 88 mm
Cutting width on rip fence	1300 mm
Table height	890 mm
Table extension	600 x 615 mm
Table enlargement	825 x 750 mm
Square table with roll	1240 x 860 mm
Speed main sawblade	3000 / 4000 / 5000 rpm
Speed scoring sawblade	8000 rpm
Scoring sawblade	120 x 20 mm
Dust extraction outlet	100 mm
Motor power output S ₁ 100%	5,5 kW (7,5 HP)
Motor power input S ₆ 40%	7,5 kW (10 HP)
Motor scoring unit	0,75 kW
Voltage	400 V
Machine dimension (W x D x H)	3420 x 3600 x 1610 mm
Weight approx.	850 kg
Art. no.	09-1180BXL

Standard accessories:

- Electric sawblade height adjustment
- Digital cutting angle indication
- Sawblade cover with infeed roller
- Eccentric holder
- Table extension
- Extractable telescopic fence
- Longitudinal stop
- Square table with roll
- Push stick
- Scoring unit with independent motor
- Tools

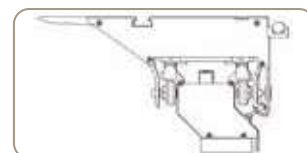

The Topcut 3200 ER is a precise sliding table saw for professional users. The torsion-free machine body made of a steel and grey-cast iron combination and the solid saw unit with a powerful drive motor guarantee a smooth run and a constant cutting speed. Additionally this machine is equipped with an electric sawblade height adjustment and a digital cutting height indication.

Topcut 3200 ER



Parallel fence with solid round rod guide can be used for cutting width of up to 1300 mm.



Tiltable parallel fence with micro-metric fine adjustment (advantage with large panels).



The amply sized sawblade cover is serially equipped with an integrated infeed roller.

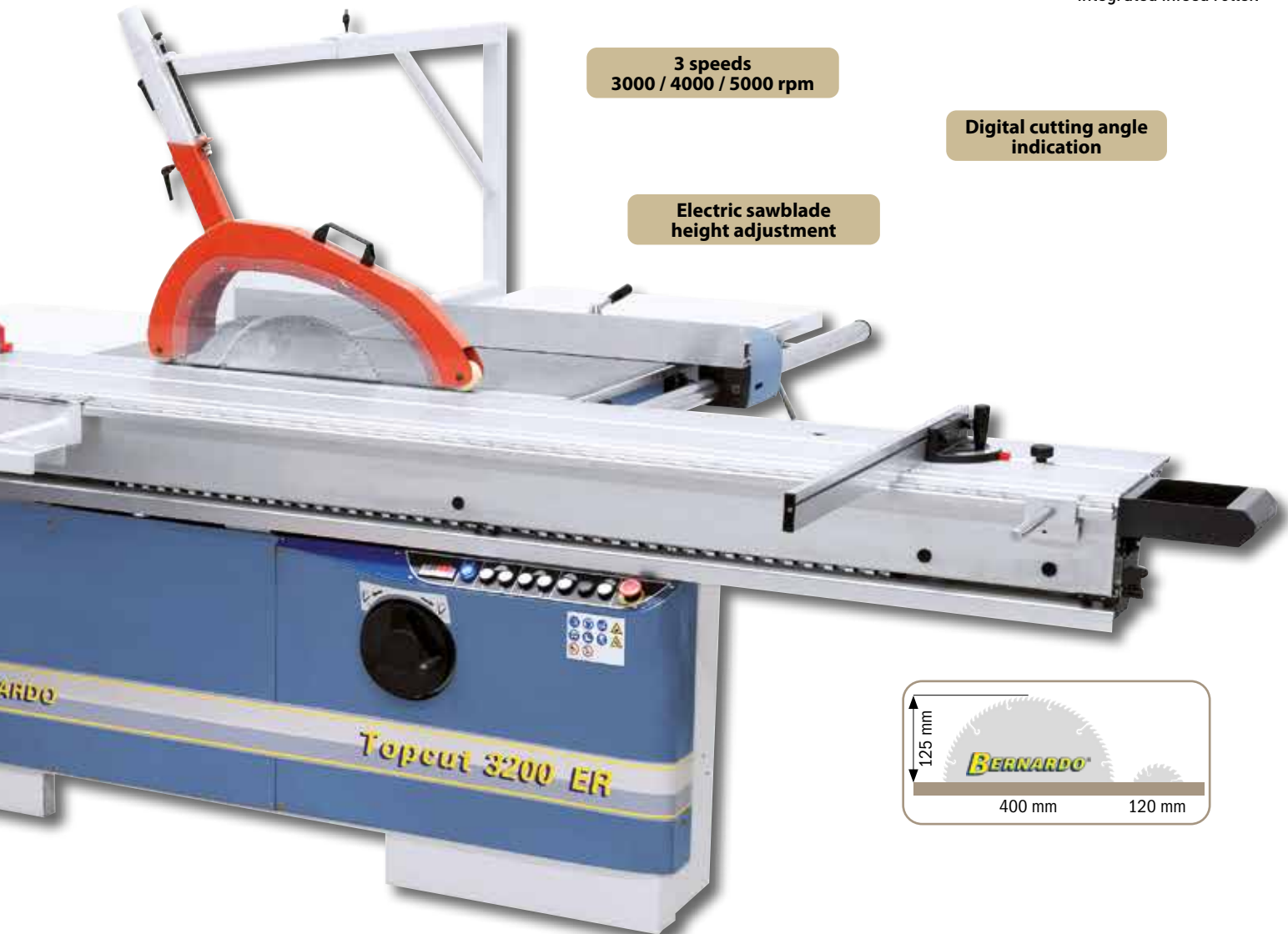

3 speeds
3000 / 4000 / 5000 rpm

Digital cutting angle indication

Electric sawblade height adjustment



Optional accessories:

Carbide sawblade 400 x 4,0 x 30 mm, 96T
Scoring sawblade 120 x 20 mm, 24T
Eccentric holder
Dust collector DC 500 E / 400 V

Art. no. excl. VAT
18-1003
18-1004
09-1425
12-2066

Optional accessories:

PU-tube diam. 100 mm (6 m)
Pneumatic clamp device f. Topcut 3200 ER
Automatic start-up ALV 10 / 1 M
Digital angle finder

Art. no. excl. VAT
12-1077
09-1426A
12-1150
31-1044

Your dealer

ORPI SL

C/ Juan de la Cierva, 23
50014 Zaragoza

Tlfn: 976 471 440

www.orpi-sl.com orpi@orpi-sl.com

BERNARDO[®]
www.bernardo.at

PWA Handelsges.m.b.H.

4020 Linz | Nebingerstraße 7a | Austria
phone: +43.732.66 40 15 | fax: +43.732.66 40 15-9
e-mail: bernardo@pwa.at | www.bernardo.at

Imprint:
All rights reserved – reproduction of images or texts or parts of these is strictly prohibited unless prior arrangements are made. Subject to technical and optical amendments. Product specifications subject to change without notice. Not responsible for printing errors or mistakes. Machines are partly displayed with optional extras. Prices subject to change. Prices in Euros, ex works (Linz, Austria), excl. any taxes. Edition 01/2024.